

SECTION 2

CHEMICALS

ITEM NUMBER	CONTROL NUMBER	PRODUCT DESCRIPTION	PRICE
3" TRICHLOR CHLORINE TABLETS			
72234	962	Pail 4#	NLA
722384	17C128049	Case 8 x 4#	NLA
722310	71C072866	Pail 10#	\$99.86
7223410	72C258137	Case 4/10#	\$399.44
722325	18C157298	Pail 25#	\$185.00
722350	20C287007	Pail 50#	\$345.00
722350-3	20C31000	Pail 55#	\$379.00

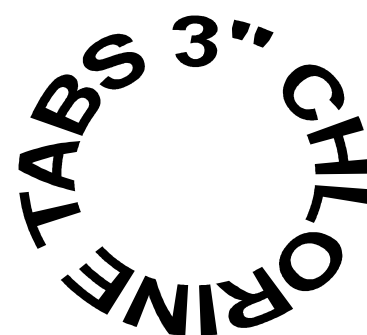

Frog Packs by King Technology			
722351	09F070008	Frog 7lb Chlorine Pack	\$87.95
722352	10F1050004	Frog 4lb Chlorine Pack	\$62.50
722353	11F1320010	Frog 2lb Chlorine Pack	\$44.25
722354	13F3110006	Frog 5400 Mineral Reservoir	\$135.00
722355	14F3109009	Frog Leap Twin Mineral Reservoir	\$129.95



GRANULAR DICHLOR CHLORINE			
72154	01C028542	Pail 4#	\$42.00
721584	02C228252	Case 8 x 4#	\$329.59
721125	03C166037	Pail 25#	\$239.82
721150	07C332116	Pail 50#	\$440.00

CHLORINE STABILIZER—Cyanuric acid			
73384	21C019373	Pail 4#	\$27.98
733884	22C150005	Case 8 x 4#	\$220.00
73312	23C010291	Jar 2# Powder	\$15.00
733124	24C125003	Case 12 x 2#	\$170.00



CHLOR-OUT--- (CHLORINE NEUTRALIZER—Sodium Sulfite)			
R1492-1	45C0011152	Jar 2# Powder	\$16.11
R1492-12	46C134585	Case 12 x 2#	\$194.40
R1492-25	97C113944	25# Pail	\$164.48

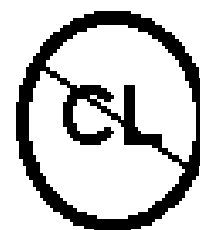

BROMINE TABS---FOR POOLS & SPAS			
72584	01B057192	Pail 4#	\$77.28
725884	02B433863	Case 8 x 4#	\$586.30
725825	03B223404	Pail 25#	NLA
725850	04B483840	Pail 50#	\$530.00
725850-2	04B488001	Pail 50#, 3-5 drums	CALL US!
725850-3	04B476005	Pail 50#, 6 or more drums	CALL US!



SECTION 2

CHEMICALS

ITEM NUMBER	CONTROL NUMBER	PRODUCT DESCRIPTION	PRICE
-------------	----------------	---------------------	-------

LIQUID CHLORINE-*Sodium Hypochlorite*

R1050-5	01U007050	Single gallon container	\$8.95
R1050-7	02U024009	Case 4 x 1 gallon containers	\$33.00
R1050-710	03U022104	Case lots 10 or more	\$28.85

LIQUID CHLORINE

CARBOYS--5 Gallon Chlorine

R1050-6	04U027695	Carboy 5 gallon	\$39.95
R1050-610	06U024681	Carboy 5 gallon, 10 or more	\$32.50
R1050-015	07U087303	Deldrum 15 Gal.	\$115.00
DEP	08U025000	Deldrum Deposit	\$25.00
DEP	05U006000	Carboy deposit	\$6.00
CCW	085U40003	Carboy Cap Wrench	\$53.00

LIQUID ACID-*Muriatic Acid*

R1050-8	06U010341	Single gallon container	\$13.77
R1050-9	07U037751	Case 4 x 1 gallon container	\$50.33
R1050-910	08U034380	Case lots 10 or more	\$45.85
R1050-915	09U125000	Deldrum 15 Gal.	\$159.62
DEP	10U025000	Deldrum Deposit	\$25.00

LIQUID ACID



SHOCK TREATMENT



OXY CLEAR---*Non-chlorine shock, 100% Pure, 43% Active PMP*

R105-20	54C14306	Pail 25#	\$206.76
R105-50	55C277255	Pail 50#	\$400.70



CALCIUM HYPOCHLORITE-*For shock & chlorination*

R6355	29C05583	Assault 73, Bag 1# Powder	\$8.07
R6355-12	30C066923	Assault 73, Bag 12X1# Powder	\$94.67

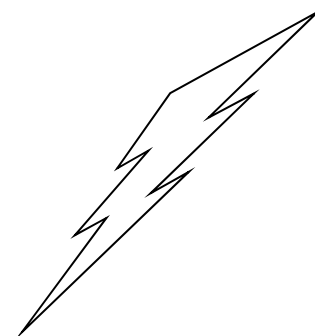

SECTION 2

CHEMICALS

ITEM NUMBER	CONTROL NUMBER	PRODUCT DESCRIPTION	PRICE
-------------	----------------	---------------------	-------

POOL FIRST AID: For disastrous emergencies...contains powerful enzymes & clarifier.
Clean-up dead algae, oil spills, antifreeze residue & other contamination.

03122	14NC024068	Single 2 Liter First Aid	\$34.38
03122-6	14NC139929	Case of 6-2 liter First Aid	\$199.88

PHOSfree Treats pools with high phosphate levels 300-1000 ppb.

05221	80NC026129	Single 2-liter PHOSfree (Treats 40,000)	\$37.31
05221-6	81NC151869	Case of 6/2-liter PHOSfree	\$216.94
05121	82NC034848	Single 3-liter PHOSfree (Treats 60,000)	\$49.78
05121-4	82NC135108	Case of 4/3-liter PHOSfree	\$192.99
05236	83NC067099	3-liter PHOSfree (commercial strength)	\$95.85

POOL PERFECT + PHOSfree

The ultimate combination of phosphate removal and natural enzymes

05235	35NC041116	Single 2 Liter POOL PERFECT + PF	\$58.72
05235-6	47NC239044	Case of 6/2-Liter POOL PERFECT + PF	\$341.49

TOTAL POOL PERFECT

Natural Enzymes/Phosphates removal/Clarifer

05225	48NC35103	2-Liter Bottle TOTAL POOL PERFECT	\$50.14
-------	-----------	-----------------------------------	---------

POOL PERFECT--Enzymes eliminate oily scum lines & increase chlorine efficiency

03210	0	1 Liter Bottle POOL PERFECT (WIL)	NLA
03210-12	0	Case 12 x 1 Liter POOL PERFECT (WIL)	NLA
03220	11Y030480	2 Liter Bottle POOL PERFECT	\$42.64
03220-6	12Y173591	Case 6 X 2 Liter POOL PERFECT	\$248.98
03250	13Y233192	5-Gallon PP (commercial strength)	NLA

METALfree - Phosphate-free metal deactivator

07001	90NC022368	1-Liter METALfree	\$31.94
07001-12	91NC259888	Case 12/1 Liter METALfree	\$371.25
20701	92NC063829	1- Gal commercial Stain & Scale	\$91.18

POOL MAGIC --Enzyme Treatment---Treats 20K gals.

Wake your pool up and put it to bed with cold water Treatment

03722	18NC017279	Single 1 Liter (Enzyme only) (Spring)	\$24.67
03722-12	19NC280803	Case of 12/1 Liter	\$286.86
05141	29NC022034	Single 1 Liter (Phosphate Combo Fall)	\$31.47
07431	31NC44335	CYA ACID REMOVAL KIT	NLA



**NATURAL
CHEMISTRY**



**NATURAL
CHEMISTRY**

SECTION 2

CHEMICALS

ITEM NUMBER	CONTROL NUMBER	PRODUCT DESCRIPTION	PRICE
-------------	----------------	---------------------	-------

ALGAEICIDES

ALGAE-ZONE "60"--- 60% Concentrate

R1031-1	40C023603	Bottle 32 oz	\$34.09
R1031-12	41C274897	Case 12 x 32 oz	\$400.93

ALGAE Break 90

406303-1	48C025000	Bottle 32 oz	\$32.94
406303-12	49C266810	Case 12 x 32 oz	\$355.75

STAIN PREVENTION & REMOVAL

SEQUEST--- Stain & scale protection

R1035-1	63C020495	Bottle 32 oz	\$28.86
R1035-12	64C234808	Case 12 x 32 oz	\$330.71

SCALE-free --- Prevents calcium & mineral scale build-up

R07511	12NC035237	2-Liter Scale-free	\$50.34
--------	------------	--------------------	---------

METALfree --- Phosphate-free metal deactivator

07001	90NC021098	1-liter Pool METALfree	\$31.94
07001-12	91NC245178	Case 12/1 liter Pool METALfree	\$371.25

STAIN ELIMINATOR--Removes ugly iron & copper stains

R1208-1	83C0022811	Jar 2# Powder	\$32.13
R1208	84C0264575	Case 12 x 2#	\$372.64

WATER CLARIFIERS

NATURE'S POOL CLEAR--- Chitin based 4-in-1 Clarifier

R6340	57C017265	32 oz Bottle	\$23.31
R6340-12	58C199108	Case 12 x 32 oz	\$269.06

POWER FLOC-- Liquid flocculant

R6330	33C012488	Bottle 32 oz	\$16.86
R6330-12	340143069	Case 12 x 32 oz	\$193.32

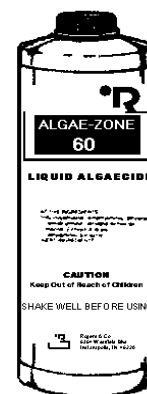

**NATURAL
CHEMISTRY**



SECTION 2

CHEMICALS

ITEM NUMBER	CONTROL NUMBER	PRODUCT DESCRIPTION	PRICE
-------------	----------------	---------------------	-------

WATER BALANCERS

pH INCREASER---Sodium carbonate

R4524	25C017381	Pail 10#	\$23.49
R4524-4	26C067067	Case 4 x 10#	\$90.62
R1050-02	09U043678	50# bag	\$54.59

pH DECREASER---Sodium Bisulfate

R4109	27C009526	Pail 5#	\$12.87
R4109-4	28C073604	Case 8 x 5#	\$99.46
R4109-50	29C036005	50# Bag	\$54.00

TOTAL ALKALINITY INCREASER---Sodium bicarbonate

R6370	38C017119	Pail 10#	\$23.13
R6370-4	39C065853	Case 4 x 10#	\$88.99
R2513	40C036764	25# Pail	\$49.68
R6370-50	41C039006	50# bag	\$51.00

CALCIUM HARDNESS INCREASER--- Calcium chloride

R6380	36C018537	Pail 10#	\$25.04
R6380-4	37C071409	Case 4 x 10#	\$96.49
R6380-50	84C067708	50# Pail	\$91.49

SPECIALTY CHEMICALS

POOL ANTI-FREEZE- For winterizing pools & spas

R10306-1	01AF09034	Gallon jug	\$12.04
R10306-2	02AF050703	Case 6 X 1 gallon	\$67.60

STOP LEAK--- Stops minor water leaks

R482200	01S050648	Stop Leak Bottle 32 oz	\$69.02
---------	-----------	------------------------	---------



LEAK

SECTION 2

CHEMICALS

ITEM NUMBER	CONTROL NUMBER	PRODUCT DESCRIPTION	PRICE
OIL & SCUM ABSORBERS			
TB-1	05SL07144	SCUMBUG, controls oily water line	\$9.01
BM-1	07SL08466	ULTRAMITT--fits the hand, cleans scum	\$12.08
58307-000	08SL08940	SKIMMER SOCKS 5 per package	\$12.76

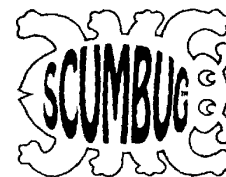

CLEANING CHEMICALS			
FILTER CLEANER ---Cleans sand, cartridges & DE elements			
R1033-1	69C010414	Bottle 32 oz	\$14.66
FILTER BLASTER ---Instant spray & rinse cleaner			
R400720	71C014058	Bottle 32 oz	\$19.79
TILE & VINYL CLEANER --All purpose pool cleaner			
R1040-91	73C005846	Bottle 32 oz (WIL)	NLA
R406640A	75C020747	Bottle 32 oz TILE MAX PLUS (WIL)	NLA



COVER CLEANER & DEODORIZER			
R4425	77C009843	Bottle 32 oz	\$13.30
R4425-12	78C109051	Case 12 x 32 oz	\$147.37
WIPE OUT --- The "Eco Friendly" cleaner			
R1050	81C011651	Bottle 32 oz	\$15.60
R1050-12	82C130002	Case 12 x 32 oz	\$180.50



SECTION 2

SPA CHEMICALS

SPA PERFECT --Enzymes eliminate oily scum lines & increase chlorine efficiency			
4131	09Y016295	1 Liter Bottle SPA PERFECT	\$23.28
4131-12	10Y189437	Case 12 x 1 Liter SPA PERFECT	\$270.86
4034	09Y028675	2 Liter Bottle SPA PERFECT	\$40.96
4034-6	10Y166736	Case 6 x 2 Liter SPA PERFECT	\$238.18



SPA-PURGE -cleans sludge and sediment out of aps piping			
4137	09Y016797	1 LITER BOTTLE SPA PURGE	\$23.99
4137-12	10Y195319	Case 12 X 1 LITER SPA PURGE	\$279.00

SECTION 2

SPA CHEMICALS

ITEM NUMBER	CONTROL NUMBER	PRODUCT DESCRIPTION	PRICE
BROMINE TABLETS			
72584	01B057192	Pail 4#	\$77.28
7258484	28433861	Case 8 x 4#	\$586.30
725825	03B223404	25# Pail	\$242.83
725850	04B483840	Pail 50#	\$530.00

BROMINE TABS

OXIDIZING SHOCK non-chlorine			
R161	85C018876	Bottle 2.2#	\$20.00
R161-12	86C0158013	Case 12 x 2.2#	\$222.35

STAIN & SCALE PREVENTER--- Stain & scale control			
R164-5	87C013803	Bottle 32 oz	\$19.44
R164-6	88C158014	Case 12 x 32 oz	\$222.56

SPA METAL FREE --- Phosphate-free metal deactivator			
R04133	92NC16795	1-Liter Spa Metal-Free	\$23.99

DEFOAMER-- -Controls foaming			
R165-5	93C08804	Bottle 32 oz	\$25.00
R165-6	94C273098	Case 12 x 32 oz	\$399.95

CLARIFER -- -Spa water clarifier			
R169-1	95C009574	Bottle 16 oz	\$13.48
R169-2	96C111168	Case 12 x 16 oz	\$156.57

ALKALINITY PLUS---Sodium Bicarbonate			
R177-1	21H004037	Bottle 1# Powder	\$5.68
R177-12	22H046752	Case 12 x 1#	\$65.85

pH PLUS---Sodium carbonate			
R175-1	99C003921	Bottle 1# Powder	\$5.85
R175-12	97C0482309	Case 12 x 1#	\$67.94

pH MINUS---Sodium bisulfate			
R176-1	98C05072	Bottle 1-1/2# Powder	\$7.14
R176-12	98C058708	Case 12 x 1-1/2#	\$82.67

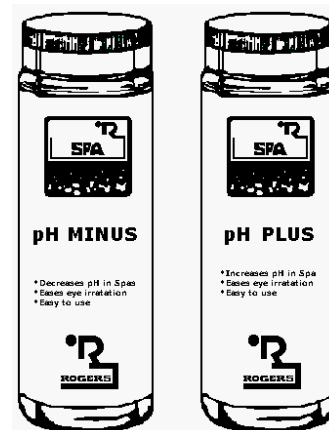

SECTION 3

WATER TESTING

ITEM NUMBER	CONTROL NUMBER	PRODUCT DESCRIPTION	PRICE
-------------	----------------	---------------------	-------

TAYLOR TEST KITS

COMMERCIAL TEST KITS

K2005	25Y060405	Complete™ High Range DPD Test Kit: Free & Total chlorine .5-5 PPM Bromine 1-10 PPM pH 7.0-8.0 Acid and base demand Total alkalinity Calcium hardness cyanuric acid	\$86.28
K2005C	26Y7843894	Complete™ High Range DPD Test Kit with 2oz Reagents: CASE OF EIGHT (Performs same test as K2005 Above)	\$1,230.90
K2006	59T445141	Complete™ Chlorine FAS-DPD Titration Test Kit: CASE OF SIX (Using powders to improve accuracy) Same as K2005 except uses 9058 comparator, sanitizer tests are titrations to improve accuracy & eliminate color matching problems.	\$635.90
K2106	36Y425640	Complete™ Bromine FAS-DPD Titration test kit: CASE OF SIX (Using powders to improve accuracy) Sanitizer tests are titrations to eliminate color matching problems.	\$608.06



LaMotte ---Water Testing

2086	37LA229859	ColorQ2xPro 7 Digital Test Kit	\$328.35
R2056-R	38LA062970	ColorQ Pro 7 Reagents Refill Kit	\$89.96

TAYLOR REPLACEMENT REAGENTS

(Larger sizes available upon request)

R-0001-A	25T03741	#1 DPD, ¼ oz bottle	\$5.35
R-0001-C	44T07496	#1 DPD, 2 oz bottle	\$10.71
R-0002-A	26T03691	#2 DPD, ¼ oz bottle	\$5.43
R-0002-C	45T07722	#2 DPD, 2 oz bottle	\$11.35
R-0003-A	27T03957	#3 DPD, ¼ oz bottle	\$5.65
R-0003-C	46T08442	#3 DPD, 2 oz bottle	\$12.05
R-0004-A	43T03357	#4 pH, ¼ oz bottle	\$4.79
R-0004-C	47T05510	#4 pH, 2 oz bottle	\$7.88
R-0004-E	42T17821	#4 pH, 16 oz bottle	\$25.57



SECTION 3

WATER TESTING

ITEM NUMBER	CONTROL NUMBER	PRODUCT DESCRIPTION	PRICE
TAYLOR REPLACEMENT REAGENTS			
R-0005-A	28T03255	#5 ADR Sulfuric acid, ¼ oz	\$4.79
R-0005-C	90T05269	#5 ADR Sulfuric acid, 2 oz	\$7.52
R-0006-A	29T03255	#6 BDR Sodium Carb, ¼ oz	\$5.96
R-0006-C	89T05028	#6 BDR Sodium Carb, 2 oz	\$7.39
R-0007-A	30T03067	#7 Thiosulfate, ¼ oz	\$4.39
R-0007-C	31T04828	#7 Thiosulfate, 2 oz	\$6.89
R-0008-A	49T02880	#8 Total Alkalinity, ¼ oz	\$4.12
R-0008-C	48T05228	#8 Total Alkalinity, 2 oz	\$7.45
R-0009-A	32T02889	#9 Sulfuric Acid, ¼ oz	\$4.12
R-0009-C	50T04760	#9 Sulfuric Acid, 2 oz	\$6.81
R-0010-A	33T03720	#10 Calcium Buffer, ¼ oz	\$5.32
R-0010-C	88T06045	#10 Calcium Buffer, 2 oz	\$8.64
R-0011L-A	34T05861	#11 Calcium Indicator , ¼ oz	\$8.37
R-0011L-C	35T09232	#11 Calcium Indicator, 2 oz	\$13.20
R-0012-A	36T03703	#12 Hardness Reagent, ¼ oz	\$5.30
R-0012-C	37T05419	#12 Hardness Reagent, 2 oz	\$7.96
R-0013-A	87T03021	#13 Cyanuric Acid, ¼ oz	\$4.44
R-0013-C	86T04756	#13 Cyanuric Acid, 2 oz	\$6.79
R-0013-E	88T09953	#13 Cyanuric Acid, 16 oz	\$14.25
R-1003J-A	61T05026	#R-1003J pH Indicator, ¼ oz	\$7.18
R-1003J-C	62T06254	#R-1003J pH Indicator, 2 oz	\$8.96
R-870-I	63T08281	#R-870 DPD Powder, 10 gram	\$11.83
R-871-A	64T09215	FAS-DPD Chlorine Titrating Reagent, 3/4 oz	\$13.17
R-871-C	18T12006	FAS-DPD Chlorine Titrating Reagent, 2 oz	\$17.14
R-872-A	67T08569	FAS-DPD, Bromine Titrating reagent, ¼ oz	\$13.32
R-872-C	68T12694	FAS-DPD, Bromine Titrating reagent, 2 oz	\$17.60
9056	75T09420	#9056 Comparator, "High" Cl/Br	\$13.46
9058	76T09821	#9058 Comparator, " FAS-DPD/PH "	\$14.03



SECTION 3

WATER TESTING

ITEM NUMBER	CONTROL NUMBER	PRODUCT DESCRIPTION	PRICE
-------------	----------------	---------------------	-------

RESIDENTIAL TEST KITS & REAGENTS

"All-in-One" 4-Way Test Kit : Chlorine, pH,
Total Alkalinity and Acid Demand

151186	01T028644	Single 4-in-1 test kit	\$38.49
151186-6	02T2243008	Case of 12/4-in-1 test kits	\$393.76

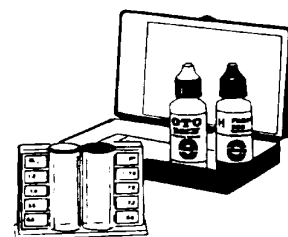

REAGENTS FOR 6-in-1 kit

161025	03T001941	#1 OTO , 1 oz. bottle	\$3.35
161025-24	04T044641	Case 24 x 1 oz. #1 bottle	\$74.40

161180	05T0012802	#2 Phenol Red, (pH) 1 oz. bottle	\$3.73
161180-24	06T046163	Case 24 x 1 oz. #2 bottles	\$76.94

161182	07T0021303	#3 Acid Demand, 1 oz. bottle	\$3.55
161182-24	08T047023	Case 24 x 1 oz. #3 bottles	\$78.37

161204	09T0018205	#4 Neutralizer, 1/2 oz. bottle	\$3.04
161204-24	10T040304	Case 24 x 1/2 oz. #4 bottles	\$67.16

161203	11T0019805	#5 T.A. Indicator, 1/2 oz. bottle	\$3.31
161203-24	12T046865	Case 24 x 1/2 oz #5 bottles	\$73.10

161200	13T01816	#3B Alkalinity Demand, 1/2 oz bottle	\$3.02
161200-24	14T039906	Case 24 x 1/2 oz #3B bottles	\$66.50

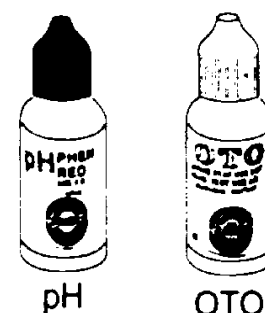

ECONOMY TEST KIT & REAGENTS

151076	20T0013098	Duo Test Kit, 2-in-1, pH/Chlorine	\$20.14
--------	------------	-----------------------------------	---------

161018	21T001810	Phenol Red reagent (pH), 1/2 oz	\$2.78
161004	22T001810	OTO reagent, 1/2 oz	\$2.78

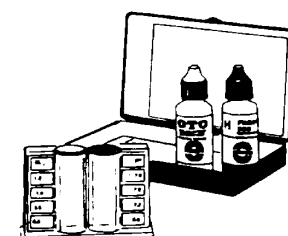

WATER ANALYSIS REAGENTS

161593	43T005657	DPD #1, 50 Tablet pack	NLA
161599	44T005868	DPD #3, 50 Tablet pack	NLA
161676	46T004096	Cyanuric Acid, 20 tablet pack	NLA

SECTION 3

WATER TESTING

ITEM NUMBER	CONTROL NUMBER	PRODUCT DESCRIPTION	PRICE
-------------	----------------	---------------------	-------

AQUA-CHEK TEST STRIPS

YELLOW: Free chlorine, pH, total alkalinity and stabilizer

511242A	52T007828	50 Test strip bottle	\$12.95
511242-12	12T086004	Case 12/50 test strip bottles	\$122.86



RED: Bromine, pH, total alkalinity and total hardness

521252	53T008377	50 Test strip bottle	\$11.96
511252-12	15T092005	Case 12/50 test strip bottles	\$131.43



7-Way: Free & total chlorine/bromine, pH, total alkalinity, cyanuric acid & total hardness

551236	54T020286	100 Test strip bottle	\$28.97
551236-6	60T111504	Case of 6-100 test strip bottles	\$159.29

Multi-Test Strips: Cyanuric Acid, TDS, LR Hardness and HR Hardness

512084	76T010379	Multi-Test Strips: 25 Test strip bottle	\$14.82
--------	-----------	--	---------



661455E	60T025684	Iron: 25 Test strip bottle	\$36.69
---------	-----------	-----------------------------------	---------

661454E	61T010514	Copper: 25 Test strip bottle	\$15.02
---------	-----------	-------------------------------------	---------

561140A	62T009331	Salt: 10 Test strip bottle	\$13.33
---------	-----------	-----------------------------------	---------



SECTION 4

CHEMICAL FEEDERS

ITEM NUMBER	CONTROL NUMBER	PRODUCT DESCRIPTION	PRICE
-------------	----------------	---------------------	-------

FLOATING FEEDERS

171086	04K12777	Adjustable chlorine dispenser #330	\$19.95
171074	05K13591	Adjustable bromine/chlorine dispenser For spas and small pools	\$20.90

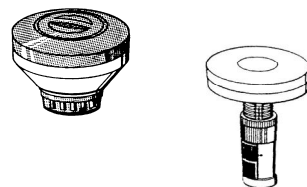

EROSION FEEDERS

RAINBOW #320C In-line chemical feeder (use 1" or 3" tabs)

171218	01K1131082	2" or 1½" piping, rated to 35,000 @3ppm	\$189.36
--------	------------	---	----------

RAINBOW #300C Off-line chemical feeder (use 1" or 3" tabs)

171022	01K0131808	Installation tubing/clamp kit for PVC 24,000 gals @ 3PPM	\$189.36
--------	------------	---	----------



Custom Molded Products erosion feeder with unions & stand

25280-400	01K147111	CMP Power-Clean in-line feeder (50K)	NLA
25280-310	02K143570	CMP Power-Clean off-line feeder (50K)	NLA
25280-200	03K069943	CMP Power-Clean mini feeder (20 K)	NLA



RAINBOW COMMERCIAL--1" Off-line hard plumbed chemical feeders

Use with 1" & 3" trichlor or bromine tabs.

171215	07K281955	#HC-3315 Adjustable flow to 97,600 gals @10 PPM	\$407.27
171230	19K308807	#HC-3330 Adjustable flow to 160,000gals @ 10 PPM	\$446.00
171240	08K306287	#HC-3340 Adjustable flow to 322,000 gals @10 PPM	\$471.20

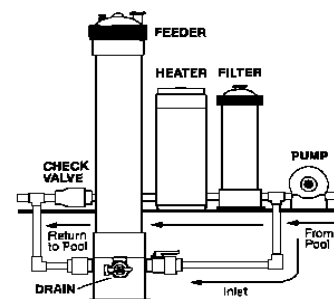

CHEMICAL FEED PUMPS

A1N10A-7T	14K0621160	BLUE & WHITE ...peristaltic type 52.5 GPD, 50 PSI	\$887.00
A1N10S-7T	17K0621160	BLUE & WHITE ...peristaltic type low feed for 300-10,000 gallons 5.25 GPD	\$887.00
A2F-24-SNGG	18K3197720	BLUE & WHITE ...peristaltic type	\$4,560.00

High Output / High Pressure Rating 11.1 GPH / 125 PSI

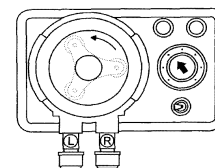

AUTO PILOT® CHLORINE GENERATOR

COMMERCIAL and RESIDENTIAL APPLICATIONS

Auto Pool Pilot Features:

...**Automatic Temperature Compensation** : Automatically adjusts the output level setting based upon changes in seasonal water temperatures, between 50° to 90° F.

...**Dual Boost Modes**: Boost / Shock mode for 24 and 72 hours.

Power Supply / Cell Manifold Assemblies

PPM1/DIG220	78SG014901	DIG220 Power Supply 120/240V with PPC1 cell/manifold assy. for pools up to 28,000 gallons.	NLA
PPM3/DIG220	79SG017242	DIG220 Power Supply 120/240V with PPC3 cell/manifold assy. for pools up to 50,000 gallons.	NLA
PPM4/DIG220	80SG020103	DIG220 Power Supply 120/240V with PPC4 cell/manifold assy. For pools up to 60,000 gallons.	NLA
DNP2	81NS10314	Nano PLUS Salt Generator w/manifold For pools up to 32,000 gallons 120V	\$1,587.00

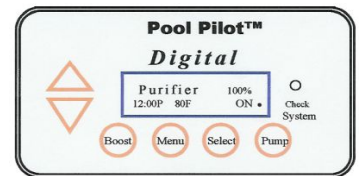
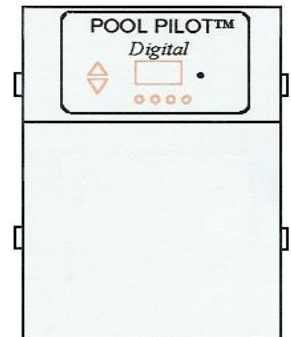

Replacement Residential Cells

PPC1	90SG04541	Replacement Cell with Unions	\$699.00
PPC3	91SG06772	Replacement Cell with Unions	\$1,042.00
PPC4	92SG09663	Replacement Cell with Unions	\$1,486.00
PPC5	93SG014124	Replacement Cell with Unions	\$2,173.00
PPM5/DIG220	96SG022991	DIG220 Power Supply 120/240V with PPC5 Commercial Cell (67K)	\$3,537.00

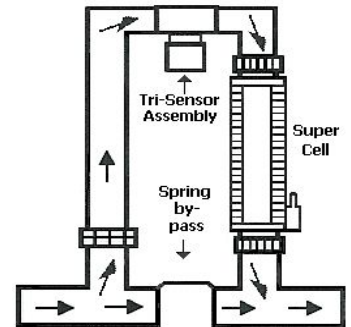

COMMERCIAL MANIFOLD ASSEMBLIES WITH CELL

Call ROGERS for commercial pool sizing. Because of swimmer load, temperature variance and pool size, the calculations are made using a program specifically designed for the more extreme pool use.

GS40	72KD9000	40# Bag Granular Pool Salt	\$14.99
R07407	73KD17466	1 Liter Cell Protect (Extends Cell Life)	\$24.94 (WIL)

BENEFITS

- > Pool maintenance is now simplified
- > No more messy chlorine tabs
- > Soft, silky feeling water
- > No vacation worries...it works without supervision
- > Improved water quality...the water glistens
- > Easily retrofits to existing pool or perfect for new pools

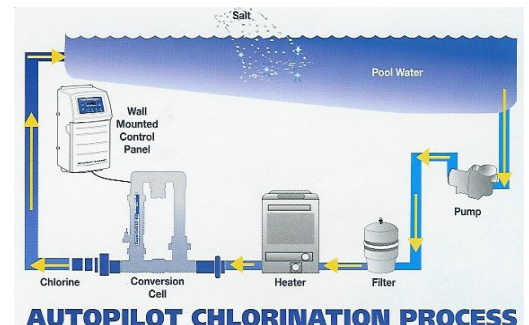

SECTION 5

SALT/CHLORINE SYSTEMS

ITEM NUMBER	CONTROL NUMBER	PRODUCT DESCRIPTION	PRICE
-------------	----------------	---------------------	-------

Pentair Intellichlor™ Chlorine Generator

- No more running out of chlorine... **NO MORE GREEN POOLS.**
- Convenience...save time by no longer having to transport handle, store or manually add chlorine to your pool
- Full diagnostic capabilities including tracking cell life
- Pays for itself by eliminating chlorine costs
- Push-button operation & easy-to-view displays
- Maintains chlorine levels 24 hours a day
- Helps eliminate eye irritation, dry skin and chlorine odor
- Easily retrofits to existing pool or perfect for new pools
- Pool water feels softer and silkier
- Absolutely safe...UL listed
- 24 Hour "Boost" cycle



**Required lbs of salt =
Pool gallons x 8.33 x .003**

Intellichlor™ In-Line Chlorine Generator

Controller panel, in-line cell assy. 15' UL cable & 2" unions

520554/56	66KD17690	IC-20 Up to 20,000 gallons, 120/240V	\$2,722.00
520555/56	67KD19360	IC-40 Up to 40,000 gallons, 120/240V	\$2,981.00
521105/56	68KD22833	IC-60 Up to 50,000 gallons, 120/240V	\$3,513.07

Replacement Intellichlor™ Cells

520554	69KD10824	IC-20 Replacement Cell only	\$1,665.66
520555	70KD12465	IC-40 Replacement Cell only	\$1,917.00
521105	71KD15854	IC-60 Replacement Cell only	\$2,439.00

520670	72KD026856	Intellichlor Acid Washing Kit	\$41.47
--------	------------	-------------------------------	---------

POOL SALT Only certain salt can be used

			NaCl
GS40	72KD900	40# Bag Granular Salt, must be 99% sodium chloride (NaCl). It cannot contain iodine or Yellow Prussia of Soda (causes staining)	\$14.99

104A	76PT015094	4" Rd. Zinc Anode Wt. Designed to stop erosion and plaster discoloration due to electrolysis. Drops into skimmer bskt.	\$20.03
------	------------	--	---------

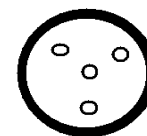

"Eco Select" is a trademark of Pentair Water Pool and Spa, Inc.

SECTION 5

OZONE SANITIZERS

ITEM NUMBER	CONTROL NUMBER	PRODUCT DESCRIPTION	PRICE
-------------	----------------	---------------------	-------



CORONA DISCHARGE (CD) or ULTRA VIOLET (UV)?

- * CD costs much less to operate
- * CD produces more grams of *ozone* than UV per hour
- * CD produces a higher concentration of *ozone than UV*

OZONE MAKES SENSE

- * Continually "*shocks*" pool
- * Breaks down chloramines
- * pH neutral
- * Makes water easier on body
- * Eliminates odors, bleaching effects and skin irritants
- * Improved water clarity
- * Reduces chemical usage



ECLIPSE--Spa CD Ozonator (May require injector manifold)

MCD-50U	23U017801	MCD-50 Spa to 1000 gallons, 110 V	\$254.40
---------	-----------	-----------------------------------	----------

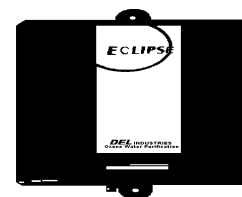

ECLIPSE--Pool CD Ozonator 110V (IU-211 injector *not* included)

EC-10	24U053501	Pools up to 7,000 gallons 110V	\$765.32
EC-20	25U07745	Pools up to 15,000 gallons 110V	\$1,106.00
EC-40	26U11372	Pools up to 40,000 gallons 110V	\$1,625.00

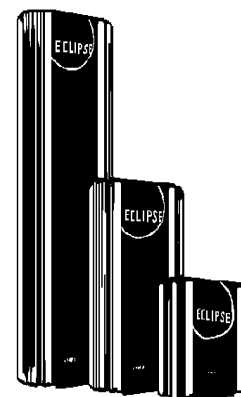

INJECTOR MANIFOLDS & ACCESSORIES

9-0210-11	07U038706	Universal injector for both 2 & 1 spd.	\$516.00
7-1140-01	08U08787	Tubing check valve 1/4"	\$11.70

OZONE LAMPS FOR DEL

9-0341	34OL075474	Lamp for ZO-910/ 912, wire leads	NLA
9-0341A	35OL097506	Lamp for ZO-901/ 912, 4 pin	NLA

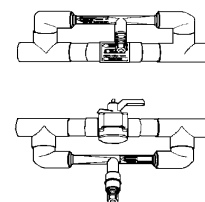

SECTION 6

HANDICAP ACCESSORIES

ITEM NUMBER	CONTROL NUMBER	PRODUCT DESCRIPTION	PRICE
-------------	----------------	---------------------	-------

THE RANGER LIFT™ by Aqua Creek

F-RNGR2	1AC0038691	THE RANGER LIFT™ (No anchors) +	CALL US
F-120PPC	1ACC002312	LIFT COVER ONLY	CALL US

FEATURES :

ADA COMPLIANT ---- RECHARGEABLE BATTERY OPERATION
 350 lb. WEIGHT CAPACITY---- 2yr. WARRANTY----
 AFFORDABLE SOLUTION FOR SMALLER IN / OUTDOOR POOLS

+ Freight

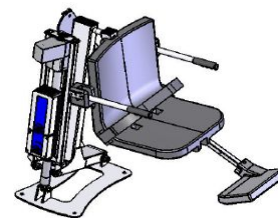

THE SPA LIFT ELITE™ by Aqua Creek

F-006SLE	2AC0055343	THE SPA LIFT ELITE 21"-68" LIFT HT +	CALL US
F-SPA8K8	2AC0003184	ANCHOR KIT ASSY. (STD.)	CALL US
F-450SLECS	2AC0003505	LIFT COVER ONLY	CALL US

FEATURES :

ADA COMPLIANT----300lb WEIGHT CAPACITY----360° ROTATION
 5 - YEAR WARRANTY----S/S CONSTRUCTION
 DESIGNED TO PROVIDE ACCESS TO SPAS

+ Freight

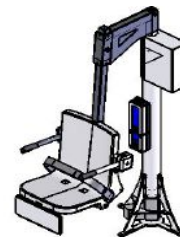

PAL LIFT™ by S.R. SMITH

200-0000	4SR0113743	PAL LIFT™ (Portable Aquatic Lift) +	CALL US
250-0000	5SR0116384	PAL LIFT™ Hi/Lo Portable Lift +	CALL US

FEATURES :

ADA COMPLIANT----300 lb WEIGHT CAPACITY----240° ROTATION
 COMPLETELY PORTABLE----24 V RECHARGEABLE BATTERY
 SINCE 1997 THE PAL HAS BECOME THE INDUSTRY STANDARD IN
 PROVIDING ACCESS TO SWIMMING POOLS.

+ Freight



aXs LIFT™ by S.R. SMITH

310-0000	5SR074244	aXs 2 LIFT™ (Semi- Permanent) +	CALL US
----------	-----------	-----------------------------------	---------

FEATURES :

ADA COMPLIANT---- 300 lb WEIGHT CAPACITY----360° ROTATION
 SEMI - PERMANENT INSTALLATION----EASILY REMOVABLE ANCHOR
 THE aXs LIFT IS PERFECT WHERE IT'S LOW PROFILE AND
 ATTRACTIVE APPEARANCE MAKES POOL ACCESS EASY.

+ Freight



ALL CHAIR LIFTS ARE F.O.B. SHIPPING POINT



Other models also available

**ADA
COMPLIANT**

SECTION 8

DECK EQUIPMENT

ITEM NUMBER	CONTROL NUMBER	PRODUCT DESCRIPTION	PRICE
-------------	----------------	---------------------	-------

STAINLESS STEEL LADDERS

Residential & Light Commercial Pools

RLF24S-2A	01L390009	2 Tread, .049" wall, 1.9" O.D.	\$556.50
RLF24S-3B	02L37	3 Tread, .049" wall, 1.9" O.D.	\$596.00
RLF24S-4C	03L56106	4 Tread, .049" wall, 1.9" O.D.	\$844.00

Commercial Pools

10001	09L536103	2 Tread, .065" wall, 1.9" O.D.	\$871.00
10004	04L64902	3 Tread, .065" wall, 1.9" O.D.	\$1,017.00
10007	05L106401	4 Tread, .065" wall, 1.9" O.D.	\$1,183.00

Heavier gauge stainless steel available upon request

HANDRAILS & GRABRAILS

2HR-4	08L020807	48" Handrail, .049" wall	\$298.00
2HR-5	09L023008	60" Handrail, .049" wall	\$326.00
2HR-6	56L35509	72" Handrail, .049" wall	\$392.00
DMS-101A	11L019202	48" Deck Mount Rail, .049" wall	\$275.00
F4H-102	13L014802	Single Grabrail, .049" wall	\$210.00

Heavier gauge stainless steel available upon request

DECK ANCHORS & ESCUTCHEONS

3019B	01A018905	Brass Anchor, 3" single	\$27.00
4019BC	02A026978	Brass Anchor, 4" single	\$38.53
PC3020B	05A051436	Brass Channel Anchor Kit, 20" x 3"	\$73.48
PC3008B	06A049337	Brass Channel Anchor Kit, 8" x 3"	\$70.48
PC4008B	07A065558	Brass Channel Anchor Kit, 8" x 4"	\$93.65

Game / Stanchion anchor

AS-100D	68T0071915	6" bronze anchor w/cover plate	\$95.89
PEOO19S	07A004829	Escutcheon, stainless steel, round	\$7.41

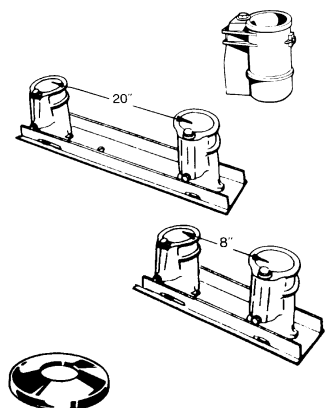
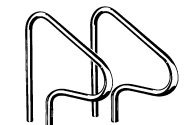
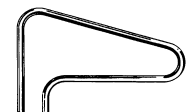
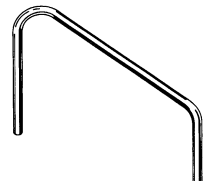
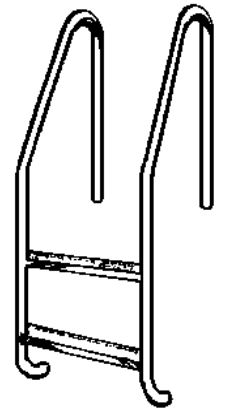

SECTION 8

DECK EQUIPMENT

ITEM NUMBER	CONTROL NUMBER	PRODUCT DESCRIPTION	PRICE
LADDER ACCESSORIES			
LTDF-103	08A042503	Ladder Tread, stainless, 3" x 20" o.c.	\$60.71
A42077-0	09A043749	Ladder Tread, Cicolac 4" x 20" o.c.	\$62.49
LTDF-101	49A017011	Ladder Tread, Cicolac, 17-1/4" Econoline	\$24.30
41494	03A043742	Brass Wedge Assy (Frost to 1990), each	\$62.49
PW	04A06172	Brass Wedge Assy for 3019BC, each	\$8.82
PW-4C	05A007942	Brass Wedge Assy for 4019BC, each	\$11.34
WRB101A	11A005793	Ladder Bumper, Female	\$8.89
WRB100A	12A003412	Ladder Bumper, Male	\$5.25
40909-1	10A019670	Tread Nut & Bolt Kit (standard)	\$28.11
60-703	22A019132	Tread Nut & Bolt Kit (for LTDF-101 tread)	\$27.33
CMP25578.000	54A052687	Recessed Step, white (set of 3)	\$75.26



SLIDES

ROGUE 2

8' Height, Rotomolded slide w/wide flume & walls
 Color Choices: *White, Blue, Gray & Taupe*
 Designed for quick, easy assembly.

Rogue2 New!

610-209-58XX	02SO29262	Curve Right or Left ROGUE2 slide	CALL US!
75-209-5865	03S095193	Flange Anchor w/hardware (Plastic)	\$126.92
PF25SGL	04S014798	Flange Anchor only (Plastic)	\$19.78
75-209-5000	05S036967	3" Aluminum Surface Deck Anchor	\$49.27
69-209-041	06S064332	Slide Tubing Repair Kit	\$85.76



CYCLONE

Available in Right curve only
 Compact style ideal for limited deck space
 4'-1" tall, low profile, rotomolded construction
 Color Choices : *Sandstone, Gray Granite & Taupe*

698-209-58XX	07S017445	Curve Right Only Slide	CALL US!
--------------	-----------	-------------------------------	----------



SECTION 8

DECK EQUIPMENT

ITEM NUMBER	CONTROL NUMBER	PRODUCT DESCRIPTION	PRICE
-------------	----------------	---------------------	-------

DIVING BOARDS

Frontier III—Intended for Residential Moderate to Heavy Use

66-209-596S2	01D0588305	6' Solid Wood Core, Flex sides	\$906.30
66-209-598S2	02D0779100	8' Solid Wood Core, Flex sides	\$1,197.80
66-209-600S2	03D095930	10' Solid Wood Core, Flex sides	\$1,473.40



Frontier III Plus for Commercial use

66-209-610S2	08D1115120	10' Solid Wood Core, Flex Sides *	\$1,594.24
66-209-6122	09D1532760	12' Solid Wood Core, Flex Sides *	\$2,218.58
66-209-6142	10D30680	14' Solid Wood Core, Flex Sides *	\$4,394.76
66-209-6162	11D3196960	16' Solid Wood Core, Flex Sides *	\$4,785.90

* ADD FREIGHT TO DIVE BOARDS *

Eureka Competitive for Commercial use

66-209-244X-1	12D440748	14' Solid Wood Core *	\$6,293.22
66-209-246X-1	13D488872	16' Solid Wood Core *	\$6,923.80

* ADD FREIGHT TO DIVE BOARDS *



Olympian Aluminum Competitive Commercial use

66-209-310X	15D2624560	10' Welded Beam Construction *	\$3,750.20
66-209-312X	16D3324160	12' Welded Beam Construction *	\$4,747.74
66-209-314X	17D5272440	14' Welded Beam Construction *	\$7,533.42
66-209-316X	18D5750500	16' Welded Beam Construction *	\$8,216.06

* ADD FREIGHT TO DIVE BOARDS *

DIVING ACCESSORIES

UF18-101	04D189740	18" Dive Stand, U-frame, S/S	\$271.36
67-209-911-ss	08A076260	Board Mounting bolt kit, 4 1/2" x 1/2"	\$108.90
TDP100	05D159490	Board Mounting bolt Kit, 5 1/2" x 1/2", S/S	\$227.90
FC-100A	06D49010	20" Rubber Fulcrum Cover	\$69.55
U100	07D068020	Dive Board Refinish Kit (white)	\$97.17



FLEX TREAD -Non skid board covering

R1539-80	01DA06875	18" wide, per lineal foot (white)	\$9.16
R1539-860	02DA03747	18" wide x 60' roll (white)	\$499.26
R1540-90	04DA03588	12" wide, per lineal foot (black)	\$4.72
PC-98T	03DA05314	Edge sealer, 4 oz, clear (Perma-Seal)	\$7.08

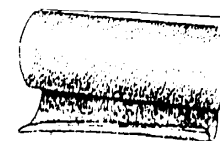

SECTION 8

DECK EQUIPMENT

ITEM NUMBER	CONTROL NUMBER	PRODUCT DESCRIPTION	PRICE
-------------	----------------	---------------------	-------

DIVING STANDS

Flyte-deck Dive Stand---Fiberglass

70-209-7362	25D05250	6' Dive Base for 6' Board	\$810.00
70-209-7382	26D06050	8' Dive Base for 8' Board	\$950.00
70-209-7402	27D07250	10' Dive Base for 10' Board	\$1,116.00



Cantilever Steel Jump Stands

001 / 026	54DS09650	Stand/jig & spring for 6' Board	\$1,452.00
001/ 028	55DS11630	Stand/jig & spring for 8' Board	\$1,786.00



Steel Dive Stand Base

70-209-501	21D22120	½ Meter Base for 8' Board	\$3,441.00
70-209-502	22D22320	½ Meter Base for 10' Board	\$3,434.00

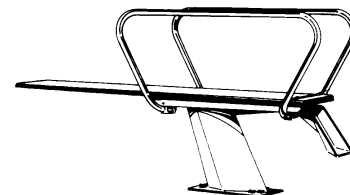

Steel Dive Stand Handrails

71-209-550	23D16750	Pair Handrails for 8' Dive Stand	\$2,579.00
71-209-551	24D17140	Pair Handrails for 10' Dive Stand	\$2,637.00

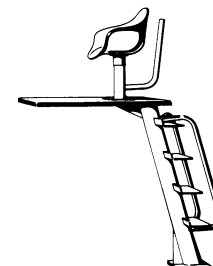

LIFEGUARD STANDS

CAT-LG-101	01G42989	Cantilever Style , flanged steel column in red oxide primer, fiberglass footboard & chair, stainless handrails, flanged column bolts for anchor/base.	CALL US!
------------	----------	--	----------

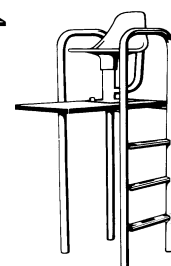

ILGS-205	02G26635	Institutional , stainless seat support umbrella holder, fiberglass footboard & seat, stainless steel frame and step treads.	CALL US!
----------	----------	--	----------

PLS-204	21F43499	Portable Style , stainless frame, seat and umbrella holder, fiberglass footboard with non-skid surface.	CALL US!
---------	----------	--	----------



SECTION 9

WHITE GOODS

ITEM NUMBER	CONTROL NUMBER	PRODUCT DESCRIPTION	PRICE
-------------	----------------	---------------------	-------

SKIMMERS

PRE-FAB/VINYL WALLS

506420	02SK19104	Bermuda, standard 1½" slip ports	\$298.46
506521	03SK215641	Bermuda WideMouth, 1½" thrd ports	\$323.23
25248-000	45SV052991	Front Access 1½" spa skimmer	\$75.68
25540-000-010	57SK010172	Std. Faceplate cover (fits Hay. & CMP)	\$13.54
25541-000-010	56SK022264	W/M faceplate cover (fits Hay. & CMP)	\$31.92



50-6420



50-6521



50-6361

GUNITE/CONCRETE

506361	03SK129370	Bermuda Gunite, 2" slip ports	\$291.00
--------	------------	-------------------------------	----------

SKIMMER EXTENSION COLLARS

516253	09SK023544	Bermuda 2½" lid seat / deck collar	\$34.20
516259	48SK029456	Bermuda 4" lid seat / deck collar	\$42.79

SKIMMER LIDS

SP1082E	28SK009940	Hayward SP1082E, square (25538-000)	\$18.54
850074	29SK09660	American Products Rd. (25544-500)	\$13.66
516215	32SK022150	Pentair--Bermuda	\$32.19
8650-58	98SK023357	SwimQuip--U-3 Rd.	\$32.67



SKIMMER & PUMP BASKETS

P287	26SK044193	Clayton & Lambert (old style)	\$59.02
38012	22SK081800	Hayward SP1082CA	\$10.90
38010	23SK07090	Hayward SP1096CA	\$9.81
38013AZ	24SK022726	American Products #850001	\$30.31
38008	25SK08439	SQ #8650-7 & B-9	\$11.23
38016	26P0010090	Hayward SPX1600M Pump Basket	\$13.63
07387Z	27P0015120	Pentair Whisper-Flo Pump Basket	\$20.20
355667	29P0019622	Pentair Super-Flo Pump Basket	\$26.94
38006	30P0012465	Sta-Rite Pump Basket C8-58P	\$20.99



SKIMMER WEIRS

P1082K	20SK020953	Hayward SP1082K	\$25.62
P280	19SK032870	Clayton & Lambert, old style 4 bolt	\$43.82
516252Z	21SK019454	Pentair--Bermuda	\$24.95
38013B	17SK017722	American Products, round #850012	\$23.63
8650-22	18SK028334	SwimQuip, hinged #8650-22	\$37.78

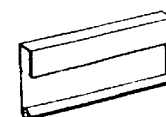

RETURNS & VACUUM FITTINGS

PRE-FAB/VINYL WALLS

862051	10F012358	1½" threaded for Vinyl liner	\$23.64
542411	87F08521	1½" socket, long body w/ nut, pre-fab	\$12.18

CONCRETE/GUNITE

542402	41F009271	Long Body, 1½" socket	\$13.33
542423	11F086504	2" Insider, fits inside 2" PVC sch. 40, accepts standard eyeball (25524-200)	\$12.37

DIRECTIONAL INSERTS, GRATES & PLUGS

540021	02F005789	"Eyeball Insert", 1½" Thrd x ¾" opening	\$8.24
540056	03F002705	Insert grate, 1½" Thrd.	\$3.85
552622	05F28850	1½" Thrd plug w/ o-ring	\$4.11
540042	06F0045308	1½" Insider eyeball assy.	\$6.47

MAIN DRAINS

RESIDENTIAL FOR VINYL-with Anti-Entrapment Cover

25515-000	03MD054123	2" side/bottom, 2-1½" bushing & plug	\$77.33
-----------	------------	--------------------------------------	---------

RESIDENTIAL FOR CONCRETE-with Anti-Entrapment Cover

25519-000	01MD049516	2" side/bottom, 2-1½" bushing & plug	\$74.62
-----------	------------	--------------------------------------	---------

ANTI-ENTRAPMENT MAIN DRAIN FRAME & GRATE COVERS

These new swimming pool frames and grates comply with ASME/ANSI A112.19.8-2007 as it relates to the "Virginia Graeme Baker Safety Act"

Colors available : Special Order Only

25507-100-000	07CMP16221	8" Rd. VGB Safety Cover (85 gpm floor)	\$23.17
9MF101	09W0085693	9" x 9" Sq. M/D Frame & Grate 203 gpm	\$122.41
12MF101	07MD129979	12" x 12", Main Drain Safety Cover opening of 69.1 sq. inches allowing for a flow of 274 GPM at a velocity of 1.3 feet per second. (floor)	\$185.66
18MF101	08W420429	18" x 18" Sq. VGB Safety Cover & Frame	\$669.67
24MF101	09W120600	24" X 24" Sq. VGB Safety Cover & Frame	\$1,467.53

MAIN DRAIN ACCESSORIES

HV101	08MD019585	Hydrostaic relief valve 2" / 1½"	\$27.97
HVC101	09MD029989	Collection Tube 1½" / 2"	\$42.82

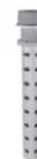

SECTION 9

WHITE GOODS

ITEM NUMBER	CONTROL NUMBER	PRODUCT DESCRIPTION	PRICE
-------------	----------------	---------------------	-------

HYDRO-THERAPY

Scalloped Design available in white, Gray, Tan & Black

25594-150	46CM036363	Spa Master™ Directional Jet 1/12" x 1" 10 gpm, 2½" Hole size, White	\$51.99
25591-230	47CM058267	Pulsator Style, 1 1/2" x 1" 10 gpm	\$83.22
25591-250	48CM058261	Twin Spin Style, 1 1/2" x 1" 10 gpm	\$83.22
25591-240	49CM060980	Massage Style, 1 1/2" x 1" 10 gpm	\$87.11
23308-000-100	50CM032361	Gunite Venturi tee, extended Jet Assy. 17-20 GPM	\$46.28



SUCTION FITTINGS

VGB Compliant Suction Fittings

25201-200	51CM047188	2" slip, white, 3 5/16" hole size 170 gpm	\$67.41
25215-000	52CM036467	2" slip, white, 3" hole size 190 gpm	\$52.08
25207-800	53CM0056130	1 1/2" MIP, white 50 gpm suction ftg.	\$80.18



AIR CONTROLS

25098-000-000	53CM018972	Top Draw Air Control, white, 1" slip	\$27.09
---------------	------------	--------------------------------------	---------



SPA SKIMMERS

25245-000-000	54CM029741	Spa Strip surface type, 1½" slip	\$42.49
---------------	------------	----------------------------------	---------

AUTOMATIC WATER FILL

T40F	55LT0116782	LETRO filler w/ Fluidmaster valve	\$179.66
T40B	56LT0116783	LETRO filler w/ brass float valve	\$179.66
T26	57LT0047637	Brass valve replacement	\$63.50
T29	58LT0028883	Fluid Master valve replacement	\$38.49



FILL SPOUTS

41240	01FS133526	1" Stainless, MPT	\$190.73
41242	02FS186884	1½" Stainless, MPT	\$266.98



SECTION 10

LIGHTING

ITEM NUMBER	CONTROL NUMBER	PRODUCT DESCRIPTION	PRICE
LIGHT BULBS			
400R/40/FL	01LB015908	400w/120v, reflector, medium base	\$21.20
400G/FL	02LB015279	400w/120v, globe type, medium base	\$20.37
21AR/40/FL	07LB017491	300w/12v, reflector, medium base	\$23.27
650139Z	04LB042756	60w/120v, Reflector, medium base	\$57.00
25A/Par 56	02LB030001	300w/12v, seal beam, (2) screw terminal	NLA

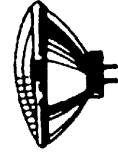
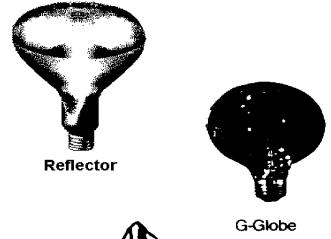

HALOGEN BULBS			
250Q/CL/MC	33HB082254	250W/120V, MiniCan, (SR0014 & 791138)	\$109.66
600053	34HB0105815	120V (AquaLumin II Bulb Kit)	\$141.08
79112400	37HB027420	75W Quartz Bulb (Sam Light)	\$36.57



LED LAMP KITS			
602076	38LK330731	AmerBrite Only White 120V/400W KIT	\$449.03
602070	39LK321632	AmerBrite Only White 12V/300W KIT	\$428.83

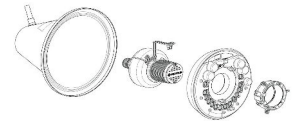

LIGHTING ACCESSORIES			
791001	01LA034321	Lens, 8 3/8", Hayward & Am. Products	\$45.77
5055-0003	18LA091214	Lens, 10 hole Swimquip	\$118.26
25549-600-000	05LA015321	Light retainer wedge kit	\$21.89
5057-0118	01LA052517	Lens gasket, 10 hole (SwimQuip)	\$70.00
SP503W	02LA065583	Lens gasket , 8-3/8" dia. (Hay.)	NLA
79101600Z	03LA028859	Lens gasket, 8-3/8" dia. (Am. Prod.)	\$38.47
789001	04LA073014	8-3/8" Lens Cover Kit 4-Colors (pool)	\$106.10

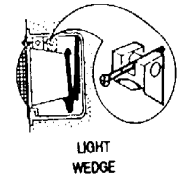
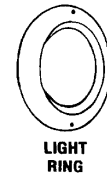

500C	03LA131235	Adapter light ring, chrome	\$174.97
500P	56LA060930	Adapter light ring, plastic	\$81.24
619963	57PN184651	Transformer 12V / 300 watt	\$263.78

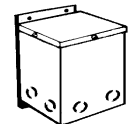

LED Bubblers & Waterfalls			
25503-150-000	14BW62001	Gunite Bubbler with 150' cord 12v AC	\$886.16
25503-050-000	15BW55802	Gunite Bubbler with 50' cord 12v AC	\$798.18
25503-30X-000	18BW044007	Faceplate kit for Vinyl / Fiberglass	\$62.21
		Color Choices: White, Gray, Blk., Tan,	
25677-23X-000	17BW60504	24" Wide LED Waterfall 6" Lip/12DC	\$864.96
25677-33X-000	18BW78005	36" Wide LED Waterfall 6" Lip/12DC	\$1,084.38
25677-43X-000	19BW91606	48" Wide LED Waterfall 6" Lip/12DC	\$1,309.10



SECTION 10

LIGHTING

ITEM NUMBER	CONTROL NUMBER	PRODUCT DESCRIPTION	PRICE
-------------	----------------	---------------------	-------

POOL & SPA LIGHTS

AMERLITE---Underwater Lights with stainless steel face rings

78441100	02L293007	400w/120v, 15' cord	\$436.00
78448100	03L037206	400w/120v, 50' cord	\$531.83
78949100	04L049208	400w/120v, 100' cord	\$723.08
78438100	05L0422209	300w/12v, 50' cord	\$604.14



AQUA-LIGHT & SPA BRITE---Underwater Lights

77168100	07L035007	250w/120v, 50' Aqua-Light (Halogen)	\$481.64
78106000	08L0277008	60w/120v, 30' Spa Brite (Halogen)	\$426.31
78108200	09L034009	60w/12v, 50' Spa Brite (Halogen)	\$485.18



HAYWARD---12 vclt (old # sp502-501)

SP0571N50	85HL698714	300W, 12V Seal Beam Type, 50' cord	\$1,068.91
-----------	------------	------------------------------------	------------

STA-RITE---10 Hole Lens Style Light

05086-0050	74L045403	500W, 120V, 50' Cord	\$648.46
------------	-----------	----------------------	----------



LIGHT NICHE

AMERLITE---Stainless Steel---1" Rear Hub

78232500	10L022200	Niche for Vinyl/pre-fab	\$325.40
78210600	11L11302	Niche for Concrete	\$162.12

AQUA-LIGHT / SPA BRITE--Stainless Steel--1" Rear Hub

78242300	12L014300	Niche for vinyl for pre-fab	\$190.60
78244300	13L094000	Niche for concrete	\$130.23



LED LIGHTING

IntelliBrite® 5g LED---Automated Pool Lighting

601200	02L080201	IntelliBrite® 400V/120V, 30' (White)	\$1,081.00
601001	03L0125401	IntelliBrite® 120V, 50' cord (Color)	\$1,726.71
601105	04L066903	IntelliBrite® 300W/12V, 30' (White)	\$993.69

IntelliBrite® 5g LED---Automated Spa Lighting

640140	05L073704	IntelliBrite® 100W/120V, 30' (White)	\$1,048.00
640120	06L098005	IntelliBrite® 120V, 30' (Color)	\$1,401.89
640130	07L095006	IntelliBrite® 12V, 30' (Color)	\$1,327.25
600054	08L0339007	IntelliBrite® Controller (multiple lights)	NLA

THE IntelliBrite® Light :

- * Fits or adapts to most light niches
- * 5 fixed colors
- * 7 color shows
- * Superior reflector



SECTION 12

SAFETY

ITEM NUMBER	CONTROL NUMBER	PRODUCT DESCRIPTION	PRICE
-------------	----------------	---------------------	-------

ROPE HOOKS

PH52	01RH012065	Rope Hooks, 1/2" clamp type	\$17.24
PH53	02RH013209	Rope Hooks, 3/4" clamp type	\$18.86

ROPE ANCHORS

PI77	04RA015807	Eyebolt type for pre-fab, CPB	\$22.58
PI70	05RA008402	External type, CPB (pair)	\$11.31
PI72	06RA014109	Eyebolt type for vinyl, CPB	\$20.13
25568	07RA10001	Plastic Rope Anchor with S/S Pin	\$14.64
41141	01RA101876	Cup type for concrete, CPB (WIL)	\$154.28
41144	02RA28702	Flush type for concrete, CPB	\$410.32
2400220	03RA047294	Eyebolt only, 1/2" threads, CPB	\$69.80

ROPE FLOATS

181016	01RF002499	Float, 3" x 5" blue & white	\$3.83
181086	02RF443007	Float, 5" x 9" blue & white	\$6.80

FLOAT KEEPERS...One float requires 4 "halves" & 2 screws

181436	05RF005660	5 x 9 on 3/4" rope (181436)	\$8.71
--------	------------	-----------------------------	--------

SAFETY LINE KITS---Rope, floats & single hook kit

181226	20RK029937	16' Safety line kit	\$38.88
181216	21RK03681	18' Safety line kit	\$47.82
181206	22RK0437049	20' Safety line kit	\$56.78
6017	23RK008310	CPB Rope hook	\$12.80

POOL ROPE

PR25-6	01RP000112	1/4" rope, per foot	\$0.20
PR50-6	03RP018450	1/2" rope, per foot	\$0.80
PR75-3	05RP001053	3/4" rope, per foot	\$1.60

EMERGENCY EQUIPMENT

221026	08SE021247	Life Hook, aluminum (#153)	\$29.38
191106	02VA033523	12' Straight Handle	\$43.28
4715	09SE058306	First Aid Kit , 24 unit	\$77.73
SB2	11SE06879	Thermal-Reflective Blanket (52" x 84")	\$9.82
EP-102P	10SE230701	Spine Board with Straps	\$439.90
EP-199	24SE024465	Strap kit for Spine Board	\$34.95

734	15SE13706	Universal Head Immobilizer	\$183.00
710	16SE10608	Rescue Tube, 50" long x 6" x 4"	\$142.00

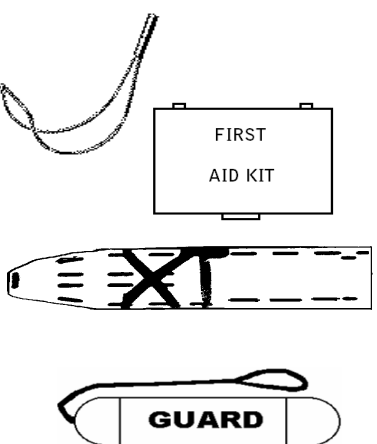
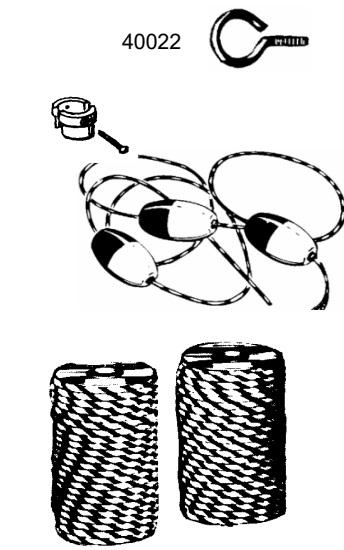
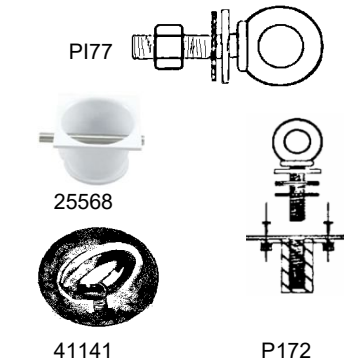
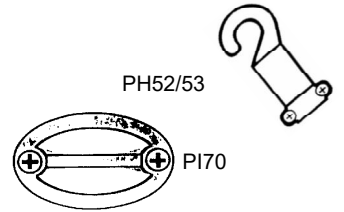

SECTION 12

SIGNS | SAFETY

ITEM NUMBER	CONTROL NUMBER	PRODUCT DESCRIPTION	PRICE
-------------	----------------	---------------------	-------

LIFE RINGS & THROW LINES

GW-20	03SE091940	20" USCG approved Life Ring	\$122.59
GW-24	04SE010205	24" USCG approved Life Ring	\$135.67
GW-30	05SE12001	30" USCG approved Life Ring	\$168.37
P-20	01SE44831	20" Plastic life ring (P20)	\$59.78
803	07SE012128	Metal life ring hanger (#803)	\$20.26
724	06SE017947	60' x 1/4" Throw Line	\$23.91

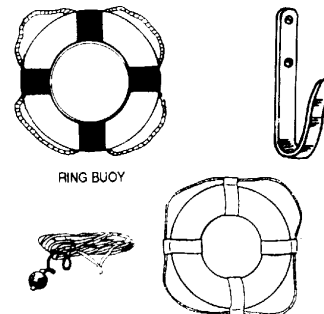

POOL & SPA SIGNS

234000	02PS034530	Hotel/Apt Pool Rules	24" x 36"	\$46.04
230900	3PS0012630	Pool Capacity	18" x 12"	\$16.38
231200	04PS012630	No Diving	18" x 12"	\$16.84
230500	13PS012760	No Lifeguard on Duty	24" x 18"	\$28.90
23850	21PS0590	DANGER HAZARDOUS CHEMICALS	18" x 24"	\$78.94
231400	35PS06160	Pool Closed	12" x 6"	\$8.80
230300	36PS2200	Spa Rules Sign	18" x 24"	\$29.00

POOL RULES

- All persons using pool do so at their own risk. Owners and management are not responsible for accidents or injuries.
- Pool is for private use only. Guests must have management permission.
- No animals allowed.
- No drinks or food permitted in pool.
- Running or unnecessary noise is not permitted at any time.
- After using pool, footwear and towels must be used when returning to building.
- Persons with long hair must wear bathing cap.
- Management reserves the right to deny use of pool to anyone at any time.

HOURS _____ to _____

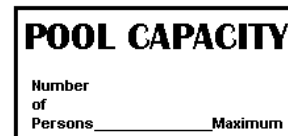

ITEM NUMBER	CONTROL NUMBER	PRODUCT DESCRIPTION	PRICE
-------------	----------------	---------------------	-------

DEPTH MARKERS

4" BLACK VINYL---Self-Adhesive non-skid surface

DM-1-#	01DM002591	Single number, specify number (WIL)	NLA
DM- 1/2	02DM002592	1/2"---Fractional number (WIL)	NLA
DMFT-IN	03DM004495	"FT" or "IN" marker (per set only) (WIL)	NLA
PS-4WC	22PP004543	"Clear" Permanent Sealer, 4 oz (WIL)	NLA

0 1 2 3 4 FT
5 6 7 8 9 IN

INLAYS, INC---6" X 6" Vinyl stick-on **OR** Ceramic, black on white 4" letters, *smooth or skid-resistant*

DM-FT-6	05DM01166	"Number" w/ "FT", single or double digit	\$15.56
DM-IN-6	06DM01166	"Number" w/ "IN", single or double digit	\$15.56
MG-6	11DM01166	Message tile, black print	\$15.56
MG-6BR	07DM012678	Message tile, black/red print	\$16.90
VIK-1	08DM032009	Vinyl Installation Kit : (5oz Sealer,	
	08DM099500	12oz Adhesive & Applicator Tool)	\$127.20

3^{FT} **3^{1/2}**

6^{IN} **7^{IN}** **8^{IN}**



INLAYS, INC --- Vinyl stick-on for Stainless Steel Walls 4 1/4" x 5 1/2" smooth surface w/4" numbers

P4100XX	12DM01166	"Number" w/ "FT", single or double digit	\$15.56
P411XXX	13DM01166	Single Message Stick-on for s/s walls	\$15.56
P411XXX	14DM01166	Multiple Message Stick-on for s/s walls	\$15.56

3^{FT} **3^{1/2}**



THERMOMETERS

141200	01TH01554	E-Z Read Combo thermometer #136 Floats or submerges on rope leash	\$23.93
141036	02TH01085	Economy Pool Thermometer #127	\$16.69

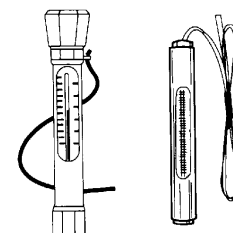

SECTION 14

POOL MAINTENANCE

ITEM NUMBER	CONTROL NUMBER	PRODUCT DESCRIPTION	PRICE
LETRO LEGEND <i>Residential Booster Pump Cleaner</i>			
105C	01LL01097001	Legend Sweep w/ booster pump and complete hose kit	NLA
LAOIN	02LL470009	Booster pump only, 115V/230V	\$584.00
LL505G	03LL0810005	Legend Sweep w/ complete hose kit * (less booster pump)	NLA

ROBOTIC INGROUND POOL CLEANER

Residential Fully Automatic Pool Cleaners Prowler 930

- > On-Board Filtration System
- > 24 Volt Operating System
- > Fully Automatic-"Plug & Play"
- > Cleans Any Size, Shape or Type of Pool
- > Programmable daily cleaning schedule with built in weekly timer
- > Climbs and Cleans Pool Sidewalls
- > Scrubs Hard to Remove Dirt
- > Removable & Re-usable Filter Bag
- > Lightweight & Easy to Use

Filtration specifications: reusable polyester felt/fine mesh self-contained bag

Drive Motor: DC hi-speed brushless, oil-filled, submersible

Pump Motor: AC 2 phase brushless, oil filled, submersible

Voltage in Water: 24 volts

360322	04LL12468	Prowler 930 Robotic I/G Pool Cleaner	\$1,600.00
--------	-----------	--------------------------------------	------------



ITEM NUMBER	CONTROL NUMBER	PRODUCT DESCRIPTION	PRICE
-------------	----------------	---------------------	-------

AQUA PRODUCTS
Commercial Automatic Pool Cleaners

AQMAX2	16AP027061	AquaMax, 21" wide	NLA
AULMAXXL	19AP062465	UltraMax, 30" wide	NLA
ULTRAKART	20AP003808	UltraKart 200, for wide body commercial	NLA
ADMXRC	21AP033879	DuraMax RC2 26" wide	NLA

Operating Volts: 24 Volts

Filtration specifications: 2 micron reusable polyester felt/fine mesh, self-contained bag

Drive Motor: DC high-speed brushless, oil-filled, submersible

Pump Motor: AC 2 phase brushless, oil-filled, submersible

Product Name	Pool size	Cleaning Coverage	Cord	Wall/Floor
Aquamax	45' to 75'	7500 Sq. Ft. per Hour	120'	NLA
Ultramax	over 80'	12,500 Sq. Ft. per Hour	120'	NLA
Duramax	Up to 45'-75'	5100 Gallons per Hour	120'	NLA



SECTION 14

POOL MAINTENANCE

ITEM NUMBER	CONTROL NUMBER	PRODUCT DESCRIPTION	PRICE
POLES & ACCESSORIES			
191306	01VA041503	8'-16', 2 Pc.Telescoping Handle	\$52.94
191088	03VA069636	12'-24', 2 Pc.Telescoping Handle	\$96.24
191106	02VA041622	12' Straight Handle	\$43.28
191128	06VA014837	6' Straight PVC Handle	\$22.82
191296	04VA0011062	Pole Lock Nut # 806	\$14.31
221036	05VA05283	Plastic Hangers, 2-hook, (145)	\$8.12
12P	12VA09546	Metal 2-hook Hanger (Nylon)	\$14.71
R-SSB	27VA006707	Handle bolt & wing nut set	\$8.94



Pole Lock Nut

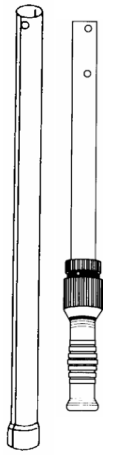
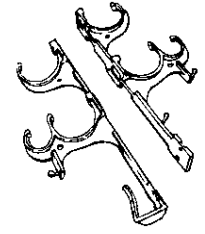

VACUUMING EQUIPMENT

VACUUM HEADS

201388	09V038548	Flex-Vac, 14" wide (203)	\$49.70
201126	10V154758	Flex-Vac, 19" wide (250)	\$206.33
201112	58V059751	Deluxe #188 Flex Vac (188)	\$77.20
201398	12V066525	"Clear View" w/brushes (196)	\$91.92
201350	13V035597	Vac head w/brushes (193)	\$45.98

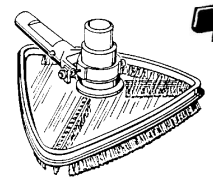
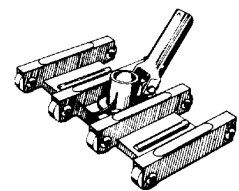

VACUUM HEAD PARTS

201526	14PV15237	Brush set for R193 vac (193R)	\$20.47
201540	15VP18248	Brush set for R 196 vac (196R)	\$24.32
201556	16PV05020	Handle spring clip, pkg. of 3 (170)	\$6.70
201486	18PV05932	Handle, replacement (192)	\$7.89
201426	19PV46304	Wheel set of 4, for FlexVac (174)	\$6.17
201456	20PV13694	Axle set of 4, for FlexVac (178)	\$18.26

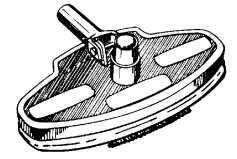

SPA WAND by Polaris

5-100-00	02SL0672815	Spa Wand, simple vac for pool & spa	\$104.02
----------	-------------	-------------------------------------	----------

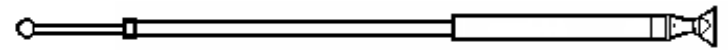

ABOVE GROUND POOL AND/OR SPA VACUUM KIT

201146	21V040169	Mini-Vac w/bag & 6' handle (204)	\$39.48
--------	-----------	------------------------------------	---------

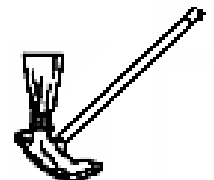

LEAF TRAP & ACCESSORIES

211084	06VA010509	#186 "Snap-Open" Leaf Trap, see-thru, large handle for carrying, bag & 3' hose	\$111.40
211516	07VA013951	Replacement mesh bag	\$18.60
211518	08VA027605	Silt bag	\$36.79
27182-020-000	09VA042982	Basket (rigid plastic)	\$57.31

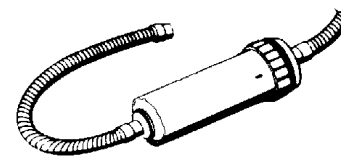

SECTION 14

POOL MAINTENANCE

ITEM NUMBER	CONTROL NUMBER	PRODUCT DESCRIPTION	PRICE
LEAF EATER			
211036	10VA051003	Leaf Eater, wheels & brush included	\$74.09
211426	12VA015507	Replacement bag, regular mesh	\$20.66
211286	13VA022138	Replacement bag, fine mesh	\$29.50

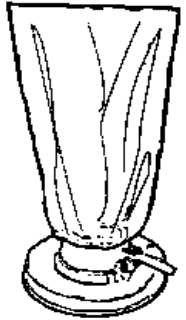

VACUUM HOSE			
HELIX VAC HOSE 1 1/2" & 2"			
HLX-30	04VH052009	30' x 1 1/2" Vac Hose	\$73.18
HLX-35	05VH061003	35' x 1 1/2" Vac Hose	\$81.39
HLX-40	06VH070005	40' x 1 1/2" Vac Hose	\$94.30
HLX-50	07VH092006	50' x 1 1/2" Vac Hose	\$119.07
HELIX-50	02VH1165407	50' x 2" Vac Hose	NLA

FORGE LOOP VAC HOSE 1 1/2"			
FL-25	08VH031800	25' x 1 1/2" Vac Hose	\$38.91
FL-30	09VH03800	30' x 1 1/2" Vac Hose	\$50.50
FL-35	10VH04500	35' x 1 1/2" Vac Hose	\$58.28
FL-40	11VH04900	40' x 1 1/2" Vac Hose	\$66.78
FL-50	12VH07900	50' x 1 1/2" Vac Hose	\$118.89

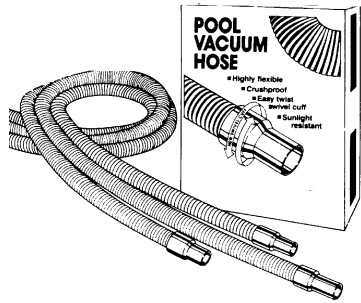

FORGE LOOP VAC HOSE 1 1/4"			
FL-24AG	13VH027429	24' x 1 1/4" Vac Hose	NLA
FL-30AG	14VH033845	30' x 1 1/4" Vac Hose	NLA
FL-36AG	15VH040421	36' x 1 1/4" Vac Hose	NLA

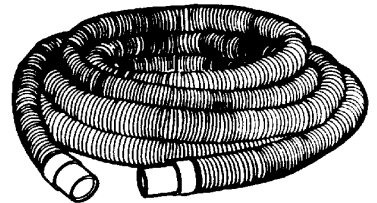

PUMP/POOL CUFFED CONNECTING HOSE			
R1249-3	20VH011807	1 1/2" x 3' Cuffed Hose	NLA
R1249-6	21VH017958	1 1/2" x 6' Cuffed Hose	NLA
R1248-3	22VH010552	1 1/4" x 3' Cuffed Hose	NLA
R1248-6	23VH015655	1 1/4" x 6' Cuffed Hose	NLA

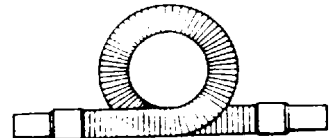

VACUUM ACCESSORIES			
51-0166	01HC2100	Cyclac 1 1/2" vacuum adapter	\$2.80
PA00129	03HC03900	Vac Hose End Cuff 1 1/2"	\$5.20
PA00138	04HC05530	Vac Hose End Cuff 1 1/2" w/ swivel	\$7.39
PA00165	05HC06206	Vac Hose End Cuff 2" w/ swivel	NLA
SP1104-1	27VH19183	Vac Plate, 1 1/2" x 1 1/4", elbow, Hayward	\$27.40
SP1105-4	28VH24952	Vac Plate, 1 1/2" x 1 1/4", straight, Hayward	\$35.64
SP1106	29VH24958	Vac Plate, 1 1/2" x 1 1/2", straight, Hayward	\$35.64
850019	30VH14728	Vac Plate, American Products	\$19.62
50-6161	31VH23821	Vac Plate, Pentair	\$31.76

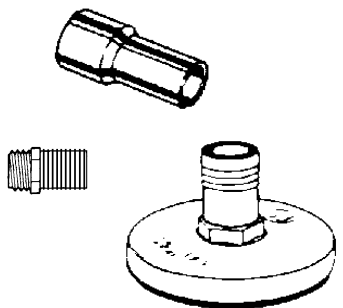

SECTION 14

POOL MAINTENANCE

ITEM NUMBER	CONTROL NUMBER	PRODUCT DESCRIPTION	PRICE
-------------	----------------	---------------------	-------

BACKWASH HOSE

859-1½ C	26VP000457	1½" See-thru blue, per foot (WIL)	\$0.64
859-1½ R	27PV079957	1½" x 200' coil See-thru blue (WIL)	\$114.21
877-2C	28PV000577	2" See-thru blue, per foot (WIL)	\$0.81
877-2R	29VP099907	2" x 200' coil See-thru blue (WIL)	\$142.71
PA00288-HS50	30VP025002	2" x 50' coil Blue Reinforced (WIL)	\$35.71

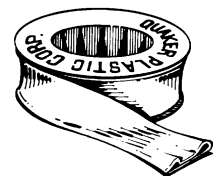

POOL-TILE SCRUBBER

8000/930	30AB025541	Mr. Scrubber w/ light duty pad (white)	\$39.29
7031/621R	33AB003394	Duo Scub Pad 4" x 6"	\$5.22



Pool "ERASE IT" Stick

81001	34SE011630	Erase It for Concrete & Plaster	\$17.88
84001	35SE011630	Erase It for Spa & Vinyl	\$17.88
85001	36SE011630	Erase It for Calcium	\$17.88
87001	37SE011630	Erase It for Tile Grout	\$17.88

LEAF NETS & RAKES

121026	15VA014924	Economy Leaf Skimmer (119)	\$19.26
121230	15VA031910	22" PRO Leaf Rake (117)	\$44.92
121186	16VA016761	Hand leaf skimmer on 4' handle (124H)	\$21.66
121106	20VA028541	22" Deep Net Rake (122)	\$36.88
420N	18VA031974	20" Deep Net Rake	NLA
830N	19VA052073	30" Deep Net Rake	NLA

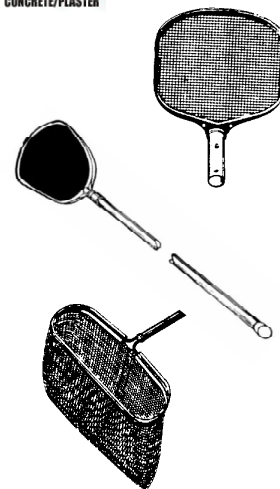

POOL BRUSHES

111046	01PB020009	Deluxe 18" Curve #92	\$25.98
111342	03PB032270	Deluxe 24" Curve #905	\$45.42
111366	05PB011196	Economy 18" Curve #912	\$14.48
111616	06PB017617	Algae Brush 6", S/S bristles	\$22.74
111626	07PB021929	Algae Brush 9", S/S bristles	\$28.60
111646	08PB036168	Algae Brush 18", S/S bristles	\$46.70
9600/9004H	68AB029397	Acid /Tile Brush w/60" Thrd. Handle	\$45.22
9600	69AB019087	Dual-sided Acid Brush only	\$29.35
9004H	70AB010318	60" Thrd. Wooden Handle	\$15.87

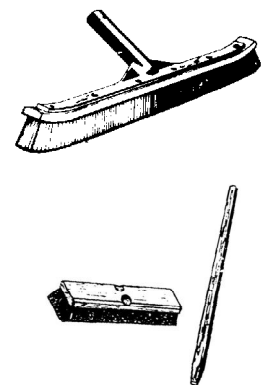

SECTION 16

SAND FILTERS

ITEM NUMBER	CONTROL NUMBER	PRODUCT DESCRIPTION	PRICE
-------------	----------------	---------------------	-------

PENTAIR FILTERS

SAND DOLLAR

- * One-piece blow-molded tank
- * 35# maximum operating pressure

145320	01F048606	SD40, 19.5" w/6 position top mt. Valve, internals (Requires 150# sand)	\$726.00
145322	02F054903	SD60, 22.5" w/6 position top mt. Valve, internals (Requires 250# sand)	\$819.00
145386	03F061004	SD80, 26" w/ 2" Top Multport Valve, internals (Requires 350# sand)	\$911.24



SAND DOLLAR

TAGELUS

- * 50# maximum operating pressure
- * Plastic top valve clamp

144126	02F061104	TA40, 19" w/6 position top mt. valve, internals (Requires 175# sand)	\$911.24
145241	03F072704	TA60, 24" w/ 6 position top mt. valve, internals (Requires 325# sand)	\$1,086.00
145240	04F0112805	TA100D, 30" w/ 2" 6 position top mt. valve, internals (Requires 600# sand)	\$1,684.00



TAGELUS

SAND FILTER VALVES

26-1050	21F022009	Side Mount 2" Slip ports (Hi-Flo)	\$340.00
26-1055	57F0262004	Side Mount 2" Thrd. Ports (SM20-3)	\$391.00
26-1173	20F017505	Side Mount 1 1/2" Thrd. ports (SM10-3)	\$261.00
26-2506	75F017106	Top Mount 1 1/2" Thrd. Ports (TA)	\$254.00
26-1185	76F0287007	Top Mount 2" Thrd. Ports (TA 100D)	\$427.00
SPO714-T	77FO17308	Top Mount 1 1/2" Thrd. Ports (Hay.)	\$258.00



GAUGES

ILPG6025-4L	21V0012620	Glycerin Filled, 0-60# pressure (Bttm.)	\$16.83
IPG602-4L	12PV05900	Pressure Gauge, 0-60# (Bttm. Mt.)	\$7.88
IPVG302-4L	13PV07450	Vacuum Gauge, 0-30"/Hg (Bttm. Mt.)	\$9.93
IPG602-4B	14PV00590	Pressure Gauge, 0-60# (Back Mt.)	\$7.88



FILTER MEDIA --- Sand & DE

10050-S	01FA1006	50# Bag Silica Sand (.45-.55 mm)	\$15.99
10050-P	02FA10004	50# Bag Pea gravel (1/8" X 1/4")	\$15.99
DE-50	23DE61434	50# Bag Diatomaceous earth	\$81.91



ITEM NUMBER	CONTROL NUMBER	PRODUCT DESCRIPTION	PRICE
-------------	----------------	---------------------	-------

TRITON® II SAND FILTERS

Residential & Light Commercial

(Select side mount dial valve from list on page 34)

140264	14F093000	TR-60, 24" Tank & internals only 3.14 SF filter area (75# pea / 250# fine)	\$1,329.00
140210	5F13030	TR100, 30" Tank & internals only 4.91 SF filter area (150# pea / 450# fine)	\$1,862.00
140243	16F19090	TR140, 36" Tank & internals only 7.06 SF filter area (275# pea / 650# fine)	\$2,728.00



TRITON® C and TRITON® C-3 SAND FILTERS

Commercial

(Select side mount dial valve from list on page 34)

140315	45F138100	TR100C, 30" Tank & internals only, 4.91 SF, 8" dome opening, 2" drain	\$1,973.00 * plus freight
140316	46F204500	TR140C, 36" Tank & internals only, 7.06 SF, 8" dome opening, 2" drain	\$2,921.00 * plus freight



* Triton C & C-3 filters are F.O.B. factory

Triton C-3 features standard 3" flange connections. Flow valving is field plumbed.

140310	47F173900	TR100C-3, 30" Tank & internals only, 4.91 SF, 8" dome opening, 2" drain	\$2,485.00 * plus freight
140342	48F24400	TR140C-3, 36" Tank & internals only, 7.06 SF, 8" dome opening, 2" drain	\$3,488.00 * plus freight



* Triton C & C-3 filters are F.O.B. factory

Jacuzzi Replacement Sand Filter Dial Valves

TM-22-H8	68F182196	2DVK-C7, 2" 7 way valve (26" SandStorm)	NLA
TM12-JL	55F121378	DVK-7, 1½" 7 way valve (Laser-bolt-on)	NLA
TM-12-H8	84F131587	DVK-7C, 1½", 7 way (Laser Clamp-on)	NLA



SECTION 16

CARTRIDGE FILTERS

ITEM NUMBER	CONTROL NUMBER	PRODUCT DESCRIPTION	PRICE
-------------	----------------	---------------------	-------

CLEAN and CLEAR by Pentair

- * Fiberglass reinforced polypropylene tank
- * Ring-Lok access to filter element for easy servicing
- * Safety tab lock assures safe operation
- * Anchor kit included to secure tank to pad



160315	56CF05240	CNC 75, 75 sq.ft. Cartridge filter	\$804.00
160316	02CF066500	CNC100, 100 sq. ft. Cartridge filter	\$1,022.00
160317	04CF08800	CNC150, 150sq. ft. Cartridge filter	\$1,356.00
160318	14CF010310	CNC200, 200 sq. ft. Cartridge filter	\$1,586.00

CLEAN and CLEAR PLUS by Pentair

- * Four extra large filter cartridges for extra long filter cycles before cleaning
- * 2" threaded ports

160340	06CF125900	CNCP320, 320 sq.ft Cartridge filter	\$1,937.00
160301	21CF142900	CNCP420, 420 sq.ft Cartridge filter	\$2,200.00
160332	23CF176900	CNCP520, 520 sq.ft Cartridge filter	\$2,721.00

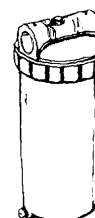

RAINBOW IN-LINE

172425C	05CF13500	Model RDC25, 25 sq. ft. area	\$192.00
172425K	65CF1600	Model RDC50, 50 sq. ft. area	\$230.00

SCAMP PORTABLE VAC SYSTEM

AL725	01H207500	SCAMP "See-Thru" #725, Mounted on Stainless Steel Cart and fitted with a 75 SF Cartridge Filter, ¾ HP (full-rated) pump, 3' cord with 15 amp GFI.	\$2,964.00
-------	-----------	---	------------

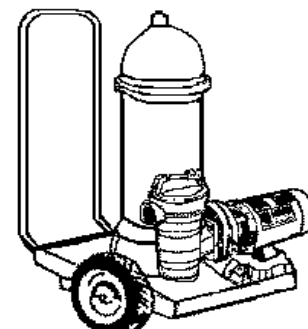

SECTION 16

REPLACEMENT CARTRIDGES

ITEM NUMBER	CONTROL NUMBER	PRODUCT DESCRIPTION	PRICE
-------------	----------------	---------------------	-------

REPLACEMENT CARTRIDGE FILTERS

C9650	03CA057009	JACUZZI CFR50.....50 sq ft,	\$77.13
C9699	05CA125007	JACUZZI CFR100...100 sq ft,	\$168.21

C9481	41JC13501	JACUZZI SHER120...120 sq ft,	\$183.70
C9482	42JC19104	JACUZZI SHER160...160 sq ft,	\$240.40

C9410	78PC010509	PENTAIR CC100, 100 sq ft (R173215)	\$144.25
C9415	79PC137002	PENTAIR CC150, 150 sq ft (R173216)	\$188.45
C9419	78PC17209	PENTAIR CC200, 200 sq ft (R173217)	\$235.14

C4625	26CA029502	RAINBOW RDC25...25 sq ft,	\$41.44
C4950	26CA037822	RAINBOW RDC25...50 sq ft,	\$51.03

SR70	14CA010785	STA-RITE, 70 sq ft	\$128.55
SR100	15CA134008	STA-RITE, 100 sq ft	\$170.25
SR135	16CA162009	STA-RITE, 135 sq ft	\$212.95

0203S	31SR785002	STA-RITE S8M150, Modular, (outer)	\$993.76
0202S	35SR274006	STA-RITE S8M150, Modular, (inner)	\$610.81

0201S	34SR582006	STA-RITE S7M120, Modular, (outer)	\$732.97
0200S	33SR274004	STA-RITE S7M120, Modular, (inner)	\$367.50

C4320	19CA21505	HAYWARD, C200RE	\$29.50
C4325	20CA021377	HAYWARD, C225RE	\$29.50

C7626	21CA038254	HAYWARD, C250RE	\$45.13
C7656	38CA062005	HAYWARD, C500RE	\$72.50

T-380R	17CA007182	HARMSCO 6 sq ft, 1-24	NLA
T-380R	18CA006521	HARMSCO 6 sq ft, 24 +	NLA

C7697	25CA153432	HARMSCO ST155	NLA
C7685	26CA116103	HARMSCO ST 105	NLA

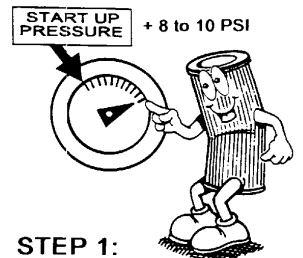
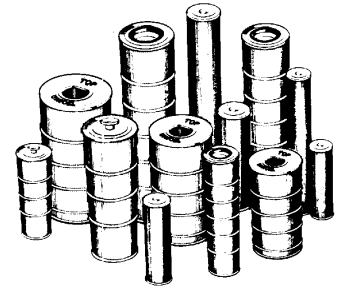

STEP 1:

Clear the cartridge when the filter canister pressure reaches a maximum of 8 - 10 PSI above the initial system or new cartridge starting pressure.

SECTION 16

FLOW METERS

ITEM NUMBER	CONTROL NUMBER	PRODUCT DESCRIPTION	PRICE
BLUE & WHITE- --Top Mount			
Price includes stainless steel mounting clamps.			
F30100P	41FM13100	1" Pipe, 5-40 GPM	\$173.59
F30150P	01FM13100	1½" Pipe, 20-100 GPM	\$173.59
F30200P	02FM14000	2" Pipe, 40-150 GPM	\$186.40
F30250P	03FM158000	2½" Pipe, 60-240 GPM	\$212.30
F3P300P	04FM12200	3" Pipe, 80-300 GPM	\$219.03
F30400P	05FM17200	4" Pipe, 125-500 GPM	\$238.74
F30600P	06FM284006	6" Pipe, 175-900 GPM	\$384.00
F30800P	07FM284000	8" Pipe, 300-1600 GPM	\$384.52



SECTION 17

SPECIAL PURPOSE PUMPS

SUBMERSIBLE & SUMP PUMPS

577301	01PF21007	Superior Cover Pump	\$225.00
574027	02PF173251	Pool Cover Pump Kit, 325 GPH, 18' Cord, 25' ½" tubing, garden hose adapter (#PCPK)	NLA
	03CB024007	CoverBlast Cover Pump Nozzle	\$31.00



REPLACEMENT SPA PUMPS

AQUA-FLO...Flo-Master "FMCP" 2-Speed Spa Pumps
 Less Strainer Housing...with Center Discharge, 1½" Ports

FMCP7	08A040200	¾ HP, 115V (AF #02607000)	\$568.16
FMCP1	09A047500	1 HP, 115V (AF #02610000)	\$670.00
FMCP15	09A059200	1½ HP, 115V (AF #02615000)	\$788.64

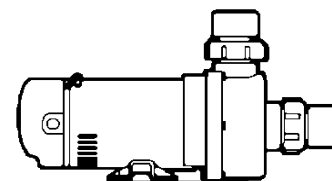

ITEM NUMBER	CONTROL NUMBER	PRODUCT DESCRIPTION	PRICE
-------------	----------------	---------------------	-------

SUPERFLO PUMPS

- * Direct replacement for Hayward ® *Super Pump*
- * Unionized fittings-1-1/2 & 2" slip
- * Integral volute and pot to reduce noise

340036	01JC05025	SUPERFLO, ½ HP, 115/230 volts (WIL)	NLA
340037	02JC05369	SUPERFLO, ¾ HP, 115/230 volts	NLA
348190 *	03JC0922250	SUPERFLO, 1.1 HP, TEFC, 115/230V, 1 Speed	\$1,123.79
340039	04JC06312	SUPERFLO, 1½ HP, 115/230 volts	NLA
342002	45317250	SUPERFLO,VST 1½ HP,VS 115/230volts	\$2,212.70



OPTIFLO PUMP

- * 1-1/2" Ports
- * Large strainer basket with see-thru lid
- * Unionized discharge port connection

347984	29JC03256	OPTIFLO, ¾ HP, 115V with 3' cord	NLA
347985	11JC03605	OPTIFLO, 1 HP, 115V with 3' cord (WIL)	\$585.33
347986	12JC04027	OPTIFLO, 1½ HP, 115V with 3' cord	NLA



PENTAIR WHISPERFLO PUMPS

Variable Speed Pump

011060	43PF18530	INTELLIFLO i2 VS PUMP 230V	\$3,014.94
011056	44PF185300	INTELLIFLO VSF PUMP 230V	\$3,014.94

Whisper Quiet...Full Service Factor...2" x 2" Ports

011578	45PF06711	½ HP, 115/230V, #WF-2	NLA
011579	01PF07349	¾ HP, 115/230V, #WF-3	NLA
015583 *	02PF089400	1.1 HP, TEFC, 115/230V, 1 Speed	\$1,391.93
011581	03PF08157	1½ HP, 115/230V, #WF-6	NLA
011582	04PF019874	2 HP, 230V, #WF-8	NLA
011583	05PF012145	3 HP, 230V, #WF-12	NLA



Whisper Quiet... 2-Speed...Full Service Factor...2" x 2" Ports

011486	91PF109039	1 HP, 2 speed, 230V # WFDS-4	NLA
011522	92PF010875	1½ HP, 2 speed, 230V # WFDS-6	NLA
011523	93PF12654	2 HP, 2 speed, 230V # WFDS-8	NLA



*** Conforms to DOE regulations for improved energy efficiency.**

SECTION 17 ANTI-BODY ENTRAPMENT PUMPS

ITEM NUMBER	CONTROL NUMBER	PRODUCT DESCRIPTION	PRICE
-------------	----------------	---------------------	-------

IntelliFlo™ VS+SVRS

Intelligent Variable Speed Pump + Safety Vacuum Release System

- * Meets ASME A112.19.17.2002 Standards
- * Onboard intelligence detects blockage and automatically shuts pump off within seconds
- * Exclusive breakthrough motor technology provides energy savings while being safety compliant
- * SVRS protection cannot be turned off
- * Safety lock-out feature (password protected) prevents pump speed settings from being changed by unauthorized personnel
- * NSF certified and UL and ETL Listed
- * 8 settable, changeable speeds ranging from 1100 to 3450 RPMs
- * No SVRS calibration required; the blockage detection/shut down function is pre-programmed
- * If the SVRS becomes disabled, the pump will not run

11057	09VS0215000	VS + SVRS pump (1/2 hp up to 3hp)	\$3,202.50
-------	-------------	------------------------------------	------------

A.O. SMITH **GUARDIAN**® SVRS Motors

Safety Vacuum Release System-----SVRS

- * Meets ASME A112.19.17.2002 Standards
- * Full body entrapment release protection
- * Motors available up to 3 HP
- * **Also** provides protection against extreme voltage variation, jammed impeller or blocked/dirty filter

Easy Installation:

- * Installs just like a standard pool motor
- * Self calibrates, no field calibration
- * Achieve a better pump system by simply replacing the motor



BG128A	51AOS0350370	Guardian® SVRS, 1 HP 115/230 volts 56J frame, threaded shaft	\$549.08
BG129A	52AOS046800	Guardian® SVRS, 1½ HP 115/230 volt 56J frame, threaded shaft	\$762.14
BG130A	53AOS56700	Guardian® SVRS, 2 HP 230 volt 56J frame, threaded shaft	\$926.44
BG131A	53AOS07670	Guardian® SVRS, 3 HP 230 volt 56J frame, threaded shaft	\$1,251.86
USQG1072A	56AO028200	Guardian® SVRS 3/4 HP 115/230 volt 48 Y frame, sq. flange, threaded shaft	\$458.98
BG848A	53AOS2831	Guardian® SVRS, 1 HP 115/230 volts 56Y frame, sq. flange, threaded shaft	NLA
BG854A	54AOS37300	Guardian® SVRS, 1½ HP 115/230 volt 56Y frame, sq. flange, threaded shaft	\$609.50
BG748A	55AOS58600	Guardian® SVRS, 2 HP, 230 volts 56Y frame, sq. flange, threaded shaft	\$954.00
BG2844A	56AOS72300	Guardian® SVRS, 3 HP 230 volts 56Y frame, sq. flange, threaded shaft	\$1,182.96



ITEM NUMBER	CONTROL NUMBER	PRODUCT DESCRIPTION	PRICE
-------------	----------------	---------------------	-------

QUICK REFERENCE			WATER LOSS CHART		
FLOW RATE					
Pool (Gallons)	6-hour Turnover	8-hour Turnover	Pool Size	Area Sq. Ft.	Gallons Per Inch Depth
20,000	56	42	14 x 28	392	247
			16 x 32	512	322
40,000	111	84	20 x 40	800	504
50,000	139	104	20 x 50	1000	630
60,000	167	106	25 x 50	1250	788
70,000	194	146	30 x 60	1800	1134
80,000	222	168	40 x 75	3000	1890
100,000	278	208	er Loss X Surface Area X .63		

**Pentair... Commercial Plastic Pump with Lint Strainer
EQ Series**

Self-priming for commercial pools and spas
 NEMA Rated Premium Grade Efficiency Motors
6" suction x 4" discharge, NSF and UL listed
 Waterfall models= low head/high flow applications
 Cam & Ramp See Through Lid



340030	04EQ65072	5 HP, 230V, 1 phase (EQ500)	\$8,677.00
340032	05EQ68012	7.5 HP, 230V, 1 phase (EQ750)	\$9,068.00
340034	06EQ73502	10 HP, 230V 460, 3 phase (EQK1000)	\$9,799.00

V-GREEN PREMIUM VARIABLE SPEED MOTORS

FULL VARIABLE 600-3450 RPM
 TIMER MODE
 NOISE REDUCTION DESIGN
 LED DISPLAY



085 SERIES					
ELV08SQ	07R060100	1/2 - 1.0 HP	115V	"Y" FRAME	980.50
ELV08C	08R060100	1/2 - 1.0 HP	115V	"C" FRAME	980.50
270 SERIES					
ECM27SQU	09R0100300	3/4 - 2.7 HP	240V	"Y" FRAME	1,636.64
ECM27CU	10R0100300	3/4 - 2.7 HP	240V	"C" FRAME	1,636.64

SECTION 17

PUMP MOTORS

ITEM NUMBER	CONTROL NUMBER	PRODUCT DESCRIPTION	PRICE
-------------	----------------	---------------------	-------

All Motors listed are single phase. Call for 3 phase pricing.

56J FRAME... Threaded Shaft... Full Service Factor

B126	07M0200320	½ HP, 115/230V	\$379.50
B127	08M024200	¾ HP, 115/230V	\$401.00
B128	09M027800	1 HP, 115/230V	\$453.00
B129	10M037600	1½ HP, 115/230V	\$613.00
B130	11M041400	2 HP, 230V	\$720.00
B131	12M058800	3 HP, 230V	\$960.00



C-Face 56J

56J FRAME... 2 Speed... Threaded Shaft... Full Service

B2975	13M039500	1 HP, 230V	\$644.00
B2977	14M043800	1½ HP, 230V	\$717.00
B2979	15M053100	2 HP, 230V	\$866.00

48Y FRAME... Threaded Shaft... Up-Rated

BN24V1	16M017900	¾ HP, 115/230V	\$293.00
BN25V1	17M019600	1 HP, 115/230V	\$320.00
BN35V1	18M022800	1½ HP, 115/230V	\$373.00



Through Bolt Mount
48/56 Base Mtg.

48Y FRAME... Threaded Shaft... 2-Speed... Up-rated

BN37V1	19M026100	1 HP, 115V, 2 speed	\$427.00
BN50V1	20M033300	1½ HP, 115V, 2-speed	\$543.00
BN51	21M036700	2 HP, 230V, 2-speed	\$600.00

48Y SQUARE FLANGE... Threaded Shaft... Full Service

SQ1072	26M025000	¾ HP 115/208/230V (Sta-Rite)	\$408.00
QC1102	27M032300	1 HP 115/208/230V (Sta-Rite)	\$527.00
SQ1152	28M037200	1½ HP 230V (Sta-Rite)	\$608.00
SQ1202	29M044620	2 HP 230V (Sta-Rite)	\$753.00

56Y SQUARE FLANGE... Threaded Shaft... Full Service

B2847	22M025400	¾ HP, 115/230V	\$415.00
B2848	23M029500	1 HP, 115/230V	\$483.00
B2858	24M03990	1½ HP, 115/230V	\$650.00
B2748	25M046100	2 HP, 230V	\$753.00
B2844	26M057100	3 HP, 208/230V	\$931.00



Square Flange 56Y

56Y SQUARE FLANGE... 2-Speed... Threaded Shaft... Full Service

B2982	58M042500	1 HP, 230V, 2 speed	\$695.00
B2983	59M038000	1 HP, 230V, 2 speed	\$801.00
B2984	60M060800	1 HP, 230V, 2 speed	\$1,022.00

SECTION 18

ITEM NUMBER	CONTROL NUMBER	PRODUCT DESCRIPTION	PRICE
-------------	----------------	---------------------	-------



Pentair Ultra Temp Heat Pumps

*** Add 1,000 if you add a chiller***

460931	51HP36261	Pentair Ultra Temp 90,000 BTU 90,000 BTU's / 6.0 COP @ 80°	\$5,411.00
460932	52HP40282	Pentair Ultra Temp 110,000 BTU 110,000 BTU's / 6.2 COP @ 80°	\$6,012.00
460933	53HP43513	Pentair Ultra Temp 125,000 BTU 125,000 BTU's / 6.2 COP @ 80°	\$6,493.00
460934	54HP51574	Pentair Ultra Temp Heat Pump 140,000 140,000 BTU's Heat @ 80°	\$7,696.00

Standard Features

- * Digital control panel displays pool temperature and monitors operating status of the unit
- * Titanium Heat Exchanger not affected by aggressive water chemistry
- * Commercial grade Scroll type compressor
- * *Auto Heat* maintains pool temperature 24 hours a day, overriding the pool time clock

ADD FREIGHT

FUEL TYPE	COST PER UNIT	BTU's / 1¢
Electric	.075 / Kwh	455
LP gas	.99 / Gal	653
Oil	.99 / Gal	979
Natural gas	.65 / therm	1077
HEAT PUMP	.075 /Kwh	2093

WHY A HEAT PUMP?

- * Uses heat in the air
- * Delivers \$4-\$7 of heat for each \$1 of energy used
- * 500%-600% efficient vs. 80-85% for gas heaters
- * Very little maintenance
- * No gas lines to run
- * No LP tanks to buy
- * 15-20 year life
- * Safer---NO GAS!
- * No pilot lighting
- * Clean emissions
- * Odorless operation



HOW DOES IT WORK?

- * Uses Nature's warm air to heat liquid freon and turn it into gas
- * Warm gas compressed into *hot* gas
- * Hot gas flows into the heat exchanger & releases heat to flowing water

SECTION 18

POOL & SPA HEATERS

ITEM NUMBER	CONTROL NUMBER	PRODUCT DESCRIPTION	PRICE
-------------	----------------	---------------------	-------

JANDY JXI HEATERS Electronic Pilot

JXI200N / P	16J023347	200,000 BTU 2" Connections	NLA
JXI260N / P	17J023942	260,000 BTU 2" Connections	NLA
JXI400N / P	18J030093	400,000 BTU 2" Connections	NLA

ADD FREIGHT



JANDY LXI HEATERS ASME RATING

JXI260NC	19J030457	250,000 BTU Bronze Headers/ASME	NLA
JXI400NC	20J034367	400,000 BTU Bronze Headers/ASME	NLA

R0484301	21J001180	6" Vent Adpt. Kit (Vertical to Horizontal)	NLA
R0484303	22J001410	8" Vent Adpt. Kit (Vertical to Horizontal)	NLA

ADD FREIGHT



JANDY "HI-E2" ---High Efficiency...Nat or LP

EHE350NC	62H078828	350,000 BTU, Nat or LP ASME	NLA
----------	-----------	-----------------------------	-----

ADD FREIGHT

- Hi-E2 Facts:**
- * 95% Efficient
 - * ASME rated
 - * Electronic ignition
 - * Direct vent w/PVC
 - * Auto power venting
 - * Bronze headers

DRAFT HOODS...CAPS

DHVC5-9	08DH1628	Draft Hood for indoor installation or vent cap for outdoor. Specify heater size	NLA
---------	----------	---	-----

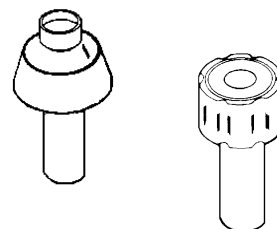

POOL HEATER

Model	125		175		250		325		400	
Temp Diff*	Maximum Area Heater (width x length)									
	0 Wind	3 1/2 MPH	0 Wind	3 1/2 MPH	0 Wind	3 1/2 MPH	0 Wind	3 1/2 MPH	0 Wind	3 1/2 MPH
15°F	875	675	1250	925	1775	1325	2300	1725	2850	2125
20°F	675	500	925	700	1325	1000	1725	1300	2125	1600
25°F	525	400	750	550	1075	800	1400	1050	1700	1300
30°F	450	325	625	475	900	700	1250	875	1425	1075
35°F	400	300	550	400	775	575	1000	750	1225	900

Natural Gas Pipe Size Requirements

Heater Size	Distance from Gas Meter		
	0-50 feet (0-15 m)	50-100 feet (15-30 m)	100-200 feet (30-60 m)
250	1 in.	1 - 1/4 in.	1 - 1/4 in.
400	1 - 1/4 in.	1 - 1/2 in.	1 - 1/2 in.

SECTION 18

POOL & SPA HEATERS

ITEM NUMBER	CONTROL NUMBER	PRODUCT DESCRIPTION	PRICE
-------------	----------------	---------------------	-------

MASTER TEMP Pool and Spa Heater...Nat or LP **

Specify Type of Gas: Natural or LP

- | | |
|--|--|
| <ul style="list-style-type: none"> * Fan assisted vent * Long-life composite header system * Eco-friendly * Outperforms industry standards | <ul style="list-style-type: none"> * Hot plate Ignition * Best-in-class energy efficiency * Rust-proof exterior is long-lasting * 2" water connections |
|--|--|

461058N	01M13980	125,000 BTU, DSI Electronic Ignition	\$2,031.85
461060P		* Fan assisted venting system 1 1/2"	
460792N	02M250200	175,000 BTU, DSI Electronic Ignition	\$3,471.00
460793P		* Fan assisted venting system 2"	
460732N	03M269500	250,000 BTU, DSI Electronic Ignition	\$3,917.00
460733P		* Fan assisted venting system 2"	
460736N	04M337700	400,000 BTU, DSI Electronic Ignition	\$4,700.00
460737P		* Fan assisted venting system 2"	



** NOTE: LPG units with *Electronic Ignition* **cannot** be installed indoors **without** fan assisted venting.

460771N/P	04M036500	250,000 BTU ASME Master Temp	\$4,867.00
460775N/P	05M041080	400,000 BTU ASME Master Temp	\$5,478.00
461020N/P	06M038040	250,000 BTU ASME H/D Master Temp	\$5,070.00



ADD FREIGHT

VENT ADAPTERS and FLUE COLLARS

(For Master Temp pool heaters)

Vertical venting-Negative pressure

77707-0076	11M013000	4" x 6" Metal flue collar (vertical venting)	\$184.00
77707-0077	19M013000	4" x 8" Metal flue collar (vertical venting)	\$184.00

Horizontal or vertical venting---Positive pressure

77707-0086	22M139430	Appliance adapter, stainless steel	\$198.00
------------	-----------	------------------------------------	----------

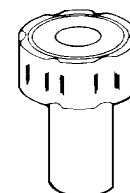

SECTION 18

POOL & SPA HEATERS

ITEM NUMBER	CONTROL NUMBER	PRODUCT DESCRIPTION	PRICE
-------------	----------------	---------------------	-------

COATES ELECTRIC HEATERS

240 VOLT SINGLE phase (208 volt available quote)

12412CE	01E020048	12 KW	\$2,806.00
12415CE	02E020276	15 KW	\$2,839.00
12418CE	03E020463	18 KW	\$2,865.00
12424CPH	04E025085	24 KW	\$3,512.00

12430CPH	05E025580	30 KW	\$3,582.00
12436PHS-3	06E033739	36 KW	\$4,723.00
12445PHS	07E034669	45 KW	\$4,854.00
12454PHS-4	08E038544	54 KW	\$5,396.00

208/240/480V, 3 phase (X: 0 FOR 208V 4 FOR 240V 8 FOR 480V)

32X12CE	09E017965	12 KW	\$2,515.00
32X15CE	10E018927	15 KW	\$2,649.00
32X18CE	11E020359	18 KW	\$2,850.00
32X24CPH	12E024042	24 KW	\$3,367.00

332X30CPH	13E024624	30 KW	\$3,448.00
32X36PHS-3	14E030506	36 KW	\$4,270.00
32X45PHS	15E031005	45 KW	\$4,340.00
32X54PHS-4	16E035583	54 KW	\$4,981.00

*** NOTE For Salt Water Application Factory recommends Models PHS-CN with Copper-Nickel Tank & Titanium Elements**

COATES COMPACT HEATER— Model #ST

- * Built-in Flow Switch
- * Manual reset hi-limit
- * Stainless Steel Tank
- * 1-1/2" inlet/outlet with unions
- * Indoor or Outdoor, UL Listed
- * 240 Volt

12406ST	18E06319	5.5 KW, 240 volt, 1 phase	\$884.00
12411ST	19E06608	11 KW, 240 volt, 1 phase	\$924.00

COATES "IN-LINE" ELECTRIC HEATER

- * Stainless Steel Vessel
- * 1 1/2" Inlet/Outlet
- * Indoor/Outdoor, UL listed
- * Pressure Switch

R-1.5ILS	20E03435	1.44 KW, 120 volt, #1.5ILS	\$481.00
R- 6ILS	21E04122	5.5 KW, 240 volt, # 6ILS	\$578.00

- * Stainless steel tank
- * Indoor or outdoor
- UL listed
- * Manual reset hi-limit
- * Status lights
- * Flow switch
- * ASME approved
- * Pressure relief valve
- * Indicator lights



SECTION 19

POOL & SPA CONTROLLERS

ITEM NUMBER	CONTROL NUMBER	PRODUCT DESCRIPTION	PRICE
-------------	----------------	---------------------	-------

PENTAIR *IntelliTouch*®

An **IntelliTouch** system needs to include:

- * Load Center
- ** Personality kit
- *** Interface kit.

* **LOAD CENTER**—Required for use with *IntelliTouch* system

521213	44C010805	Main Panel <i>Load Center</i> with circuit breaker sub-panel (breakers not included)	\$1,526.00
--------	-----------	--	------------

** **INTELLITOUCH "PERSONALITY KITS"** ---Choose one:

Single body of water...pool or spa

521224	50C23714	i9+3S Load Center Personality Kit: 2 temp sensors, 9 relays, 3 feature functions & personality panel	\$3,351.00
--------	----------	--	------------

Separate equipment systems for pool AND spa w/ one controller

521222	51C27056	i10+3D Load Center Personality kit: 10 Relays, 3 features, personality panel, 2 temp sensors	\$3,823.00
--------	----------	--	------------

*** **INTERFACE KITS**--pick 520138 and/or 520139

520138	61C08815	Indoor Control Panel--3.75" LCD screen Wired to load center or power center	\$1,245.00
520906	62C15045	MobileTouch--Wireless control panel with transceiver, 3.75" LCD	\$2,126.00



IntelliTouch
Control Panel Features:

- * Control up to 40 functions
- * Sharp resolution screen
- * Back lighted w/ auto shut-off
- * Views available on the panel:
 - water temperatures
 - heating status
 - air temperature
 - status of all equipment
 - time and date
- * Customize buttons for easy ID
- * Simple on-screen menus

IntelliTouch Accessories

521887	64C3200	iS4, 4 Function spa side remote: 150' Controls 4 circuits, LED indicator lamps	\$453.00
520198	63C1525	2-Speed relay	\$215.00

SECTION 19

AIR SWITCHES & BLOWERS

ITEM NUMBER	CONTROL NUMBER	PRODUCT DESCRIPTION	PRICE
-------------	----------------	---------------------	-------

LEN GORDON AIR SWITCHES

ADD AIR BUTTON TO AIR SWITCH KIT, IF NECESSARY

ASM-C95 921305001	07G129857	AS-MULTI COMBO-95, 120/240V, 20 amps 1 or 2 HP, on/off for single piece of equip., will control single or 2-speed pump	\$182.00
AS-TD 921805001	12G189406	AS-TD Combo 95, 120/240V, 20 amp on/off control, 10 minute time delay, 1 to 2 HP. Neutral wire required	\$266.00
AS-5TD 922994-012	13G481737	AS-5TD-30MM, 240V, 50 amp, 5 to 10 HP, 30 minute time delay	\$675.00
910100-007	08G239252	120/240V, 20 amp, 1 to 2 HP, controls 2 pieces of equipment with one air button. Controls 1 or 2 speed pump	\$335.00
951001-000	09G022159	#10 White "PowerTouch" flat air button	\$31.00
950401-000	10G024939	# 4 White "Lite Touch" air button	\$34.90
990310-000	11GPC1564	Tubing coupler	\$2.20
991020-000	12GP005962	20' Roll air tube	\$8.35
991100-000	13GP018004	100' Roll air tube	\$25.20

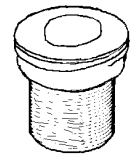
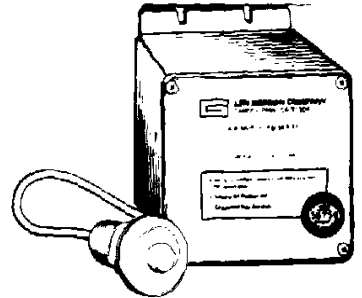

SPA BLOWERS

Residential Blowers---2" Bottom air outlet

PSB110	01G02357	JANDY Blower, 1 HP, 110V	NLA
PSB115	02G02548	JANDY Blower, 1½ HP, 110 V	NLA
PSB120	03G02831	JANDY Blower, 2 HP, 110 V	NLA
Add 5% for 240 volt			

ROTRON Commercial Blower---Belt Driven

R-505A7	05GXXXXX	2 HP, 230/460V, 3 ph (DR505AS72M)	QUOTE
R-505AW	06GXXXXX	2 HP, 115/230V, 1 ph (DR505AW58M)	QUOTE

POLARIS QT™

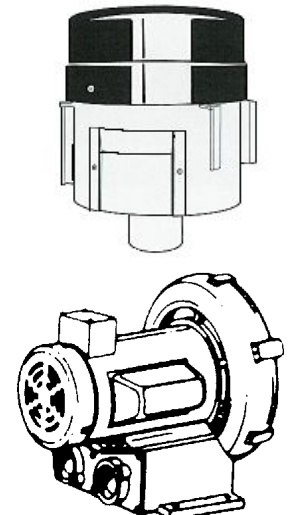

PROTECT YOUR FAMILY & INVESTMENT

- * Aesthetically pleasing
- * Custom fitted to your pool
- * Replaces conventional winter covers & water bags
- * Keeps your pool clean while protecting it from unwanted intruders and animals

NOW YOU SEE IT...
It's Summer...
It's inviting...
It's eye appealing...
IT'S BEAUTIFUL !!!

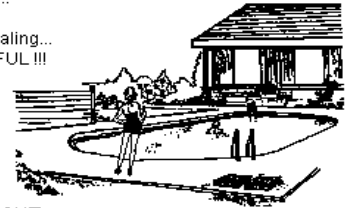

NOW YOU DONT...
It's Winter...
It's "put to bed"
It's eye appealing...
IT'S BEAUTIFUL !!!



ITEM NUMBER	CONTROL NUMBER	PRODUCT DESCRIPTION	PRIC
-------------	----------------	---------------------	------

SAFETY MESH COVERS -Rectangular
5000M STD. 4.5 oz. Material 5' X 5' Spacing

Prices are for pools having up to **2' radius corners only**.
Any other corner requires a special quotation. Call for quote.

		COVER SIZE // POOL SIZE	
SC-1632	02SC10741	18 x 34 // 16 X 32	CALL US!
SC-1836	03SC12552	20 x 38 // 18 x 36	CALL US!
SC-2040	04SC14283	22 x 42 // 20 x 40	CALL US!
SC-2044	05SC15624	22 x 46 // 20 x 44	CALL US!
SC-2550	09SC21385	27 x 52 // 25 x 50	CALL US!
SC-3060	11SC25016	33 x 63 // 30 x 60	CALL US!
CUT OUT	07SC01744	Cut-outs...each	CALL US!
STEP	08SC01496	Step add-on...4' x 8' step	CALLUS!

Custom and odd-shaped pools are our specialty. Call us for assistance and a price quote.

SAFETY " Solid " COVER Full Weight Rectangular
1000V Heavy Duty Material 12oz. (Blue , Green, Tan, Gray)

Prices are for pools having up to **2' radius corners only**.
Any other corner requires a special quotation. Call for quote.

		COVER SIZE // POOL SIZE	
SSC-1632	02SC014516	18 x 34 // 16 X 32	CALL US!
SSC-1836	03SC017017	20 x 38 // 18 x 36	CALL US!
SSC-2040	04SC018926	22 x 42 // 20 x 40	CALL US!
SSC-2044	05SC020991	22 x 46 // 20 x 44	CALL US!
SSC-2550	09SC026832	27 x 52 // 25 x 50	CALL US!
SSC-3060	11SC048902	33 x 63 // 30 x 60	CALL US!
CUT OUT	07SC001748	Cut-outs...each	CALL US!
STEP	08SC001495	Step add-on...4' x 8' step	CALL US!

PRICES FOR ALL SAFETY COVERS INCLUDE
* Brass Concrete Anchors
* Stainless Steel Hardware
* Installation Tool
* Storage Bag

SECTION 21

WINTER COVERS

ITEM NUMBER	CONTROL NUMBER	PRODUCT DESCRIPTION	PRICE
-------------	----------------	---------------------	-------

IN-GROUND WINTER COVERS-- WATER TUBE TYPE

Water tubes not included in price

ESTATE PLUS W/ Binding--- 12 Year Limited, 3 Year Full Warranty

		COVER SIZE	//	POOL SIZE	
ESP1729	10HP01413	17' x 29'	//	12' x 24'	CALL US!
ESP1933	11HP01803	19' x 33'	//	14' x 28'	CALL US!
ESP2137	01HP02197	21' x 37'	//	16' x 32'	CALL US!
ESP2141	02HP02365	21' x 41'	//	16' x 36'	CALL US!
ESP2341	03HP02735	23' x 41'	//	18' x 36'	CALL US!
ESP2345	04HP02869	23' x 45'	//	18' x 40'	CALL US!
ESP2545	05HP03226	25' x 45'	//	20' x 40'	CALL US!
ESP2549	06HP03598	25' x 49'	//	20' x 45'	CALL US!
ESP3055	07HP04454	30' x 55'	//	25' x 50'	CALL US!

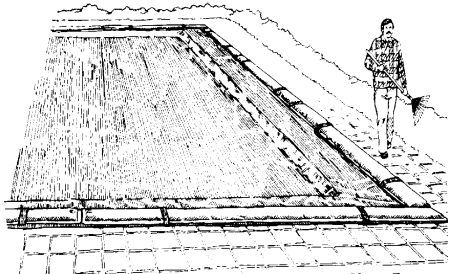
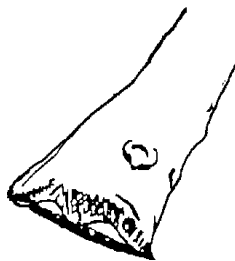

WATER TUBES

WT-8	02CA010689	8' Single Water Tube	\$17.20
WT-10	03CA012452	10' Single Water Tube	\$20.30
WT-8D	04CA0012075	8' Double Water Tube	\$19.50
WT-10D	05CA014043	10' Double Water Tube	\$22.70
4x4 PILLOW	06C015322	4' x 4' Air Pillow	\$24.75

ABOVE GROUND WINTER COVERS

ESTATE PLUS W/ Binding---12 Year Limited, 3 Year Full Warranty

		COVER SIZE	//	POOL SIZE	
ESP-16	08HP0981	16' Round	//	12' Round	NLA
ESP-19	09HP1364	19' Round	//	15' Round	NLA
ESP-22	10HP1662	22' Round	//	18' Round	NLA
ESP-25	11HP1985	25' Round	//	21' Round	NLA
ESP-28	12HP2578	28' Round	//	24' Round	NLA
ESP-32	13HP3275	32' Round	//	27/28' Round	NLA
ESP-1934	14HP2409	19' x 34' Oval	//	15' x 30' Oval	NLA
ESP-2238	15HP2934	22' x 38' Oval	//	18' x 33' Oval	NLA

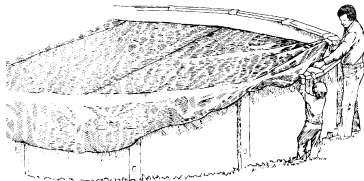

SECTION 21

WINTERIZING ACCESSORIES

ITEM NUMBER	CONTROL NUMBER	PRODUCT DESCRIPTION	PRICE
577301	01LG21000	Superior Cover Pump	\$225.00



574027	02PF173252	Pool Cover Pump Kit, #PCPK , 325 GPH, 18' cord, 25' 1/2" tubing, hose adapter	NLA
--------	------------	---	-----



RUBBER WINTERIZING PLUGS

HWP-204	15PV02100	#4 Rubber Plug, (3/4" & 1" pipe)	\$3.46
HWP-206	16PV02354	#6 Rubber Plug, (1" pool fitting)	\$3.90
HWP-207	17PV02631	#7 Rubber Plug, (1 1/4" pipe)	\$4.35
HWP-208	18PV02809	#8 Rubber Plug, (1 1/4" pool fitting)	\$4.60
HWP-209	19PV03108	#9 Rubber Plug, (1 1/2" pipe)	\$5.12
HWP-210	20PV03284	#10 Rubber Plug, (1 1/2" pool fitting)	\$7.12
HWP-211	21PV04312	#11 Rubber Plug, (2" pipe)	\$7.66
HWP-212	22PV04658	#12 Rubber Plug, (2" pool fitting)	\$6.64
HWP1-5BT	23PV10136	Universal Tapered Blow-out Plug	\$16.75
HWP5-7BT	24PV10737	Universal Tapered Blow-out Plug	\$17.70
HWP7-10BT	25PV13659	Universal Tapered Blow-out Plug	\$22.53
552622	26PV02509	Threaded plug w/ O-ring, 1 1/2"	\$3.76
25525-004-000	27PV05071	Threaded plug w/ O-ring, 2"	\$7.70



BRASS ANCHOR (Safety Cover)

MH212	09CA007153	Brass Concrete Anchor	\$11.55
MH235	11CA019735	S/S Spring only (for safety cover)	\$31.87
MH218	12CA035286	Installation Rod (for safety cover)	\$57.00

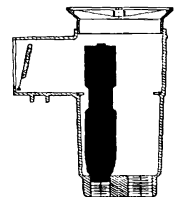

SKIMMER BLOWOUT EXTENSIONS

R1197	08SK012722	15" Skimmer Blowout Extension	\$17.80
SKG9	191K006706	9" Expansion Skimmer Insert	\$9.40

Anti-Freeze for pools & spas

R10306-1	01AF09034	Gallon jug	\$12.04
R10306-2	02AF50709	Case 6 X 1 gallon	\$67.60



ITEM NUMBER	CONTROL NUMBER	PRODUCT DESCRIPTION	PRICE
-------------	----------------	---------------------	-------

DELUXE MODEL

by
MERLIN

- * 2# Density Polystyrene Foam Inserts
- * Inserts Heat Sealed inside 6-mil Vapor Wrap
- * Aluminum "C" Channel Foam Reinforcements
- * Standard Skirt Size---3"...up to 8" No Extra Charge
- * Colors: Teak, Light Gray, Dark Gray, Blue, Tan, Forest Green
- * Bi-fold, 4" x 2" Tapered Foam Top
- * Tri-fold & Quad Fold Available
- * Three (3) Year Limited Warranty
- * 4 Security Straps with Locking Buckles

DM86	22SC07139	Up to 86"	CALL US!
DM96	23SC07507	86.5" to 96"	CALL US!
DM120		96.5" to 120"	CALL US!
DM144		120.5" to 144"	CALL US!

		PORTABLE SPAS WITH SPECIAL CUT-OUTS SUCH AS BAJA, ADD	
CO-AO	56SC00792		\$105.00

For any tri-fold or quad-fold, submit drawing for quote.

ULTRA MODEL

ULTRA MODEL---5 year limited warranty

- Supports heavy snow loads, small children, dogs, etc.
- Tough fiberglass reinforced plastic cover
- 4" x 3" Taper
- Deluxe moisture barrier---HD 6-mil co-extruded, triple layer wrap
- Aluminum "C" channel reinforcements

All spa covers must have a drawing submitted in detail before cover can be ordered.

All spa covers are special order and are to be paid in full with order.

UM86	32SC10476	Up to 86"	\$1,395.00
UM96	33SC10471	86.5" to 96"	\$1,395.00
UM120		96.5" to 120"	Quote on request
UM144		120.5" to 144"	Quote on request

Thermo-Light----- Floating Spa Cover

For larger and free-form spa covers that can be too heavy or too big with the standard construction method. Using the finest marine grade vinyl and a special foam core, the Thermo-Light is made to last and not absorb water. Dimensions are to be the water's edge...it floats inside the pool/spa on the water.

TL86	81SC09750	Up to 86"	CALL US!
TL96	82SC09753	86.5" to 96"	CALL US!
TL965		96.5" and bigger	CALL US!

SECTION 22

LINER ACCESSORIES

ITEM NUMBER	CONTROL NUMBER	PRODUCT DESCRIPTION	PRICE
-------------	----------------	---------------------	-------

LINER BEAD RETAINER

32091498	01LA030004	LOK-N-ROLL , 2/100' coils x 4/32"	\$45.00
32091499	02LA030005	LOK-N-ROLL , 1/100' coils x 5/32"	\$53.85
QP1562	03LA33345	Ribbed bead lock, 120' (QP1562)	\$11.00

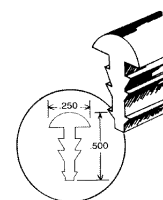

QP1562

LINER BEAD RECEIVER

QP-531	03LA007326	Top Mount, single 8' pc. (Plastic)	\$251.00
VM-1	06LA179328	Side Mount, case 15/8' (Aluminum)	\$279.00

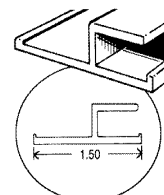

QP-531

ST144000-3	07LA185621	CP-2 Alum. White Str. Coping 3/12' cs.	\$390.00
ST096000-6	08LA259632	CP-2 Alum. White Str. Coping 6/8' cs.	\$389.50
CNO38024-4	09LA248353	CP-2 Alum. White Corner Coping 4/2'R	\$373.00
TSPK100	10LA016834	Tek Screws for coping 100pc.	\$25.25
CAW-CLIP-1	11LA002565	CP-2 Coping Clip	\$385.00

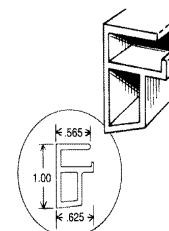

VM-1

WALL/FLOOR FOAM

WF125	71P154457	2 lb. X 1/8" x 125' Roll foam	CALL US!
-------	-----------	-------------------------------	----------

VINYL PATCH KITS

759	01VR004603	Vinyl Repair Kit, 1 oz	\$6.50
859	03VR008342	Vinyl Repair Kit, 2 oz	\$11.70
110	05VR018203	Vinyl Repair Kit, 4 oz	\$25.50
104	07VR012767	Vinyl Cement only, 4 oz	\$17.90



ITEM NUMBER	CONTROL NUMBER	PRODUCT DESCRIPTION	PRICE
-------------	----------------	---------------------	-------

INGROUND LINERS

- The selection of liner patterns and designs is vast; no more "standard liners"
- Vinyl liners are now "Price on Request"
- Please call us with your pool make, all dimensions (see drawings), and pattern desired
- Customer is ultimately responsible for all final liner dimensions
- Call for literature, patterns and/or pricing

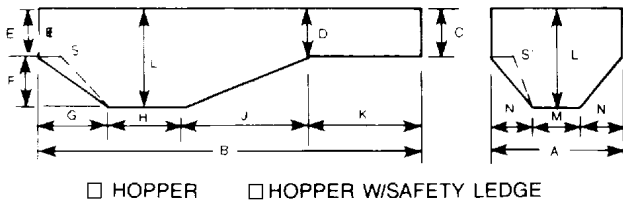

HOPPER HOPPER W/SAFETY LEDGE

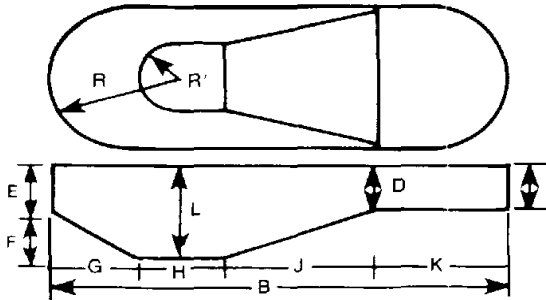

OVAL

IS HOPPER
PAD SQUARE?
 YES
 NO

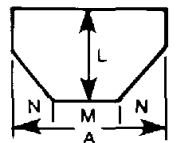

Below is a *small sampling* of vinyl liners available. There are many liner manufacturers to choose from. Patterns and prices are different between the manufacturers, therefore, final pricing may vary. Call us for more information.

1530OBL	04C00001	15' x 30' Oblong	CALL
1735OBL	05C00018	17' x 35' Oblong	CALL
1937OBL	06C00056	19' x 37' Oblong	CALL
1943OBL	07C0R006	19' x 43' Oblong	CALL
1632RT	09C00T03	16' x 32' Rectangle	CALL
1836RT	11C00A08	18' x 36' Rectangle	CALL
2038RT	10C0G0B7	20' x 38' Rectangle	CALL
2040RT	12C00026	20' x 40' Rectangle	CALL

ANY Shape Liner Available

Kidney ?
True L ?
Lazy L ?
Grecian ?
Roman ?
Free Form?

**We are the Liner Experts
!
Call ROGERS !**

ALUMINUM COPING

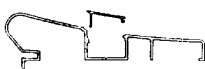

CP6



CP8



CP1



CP2

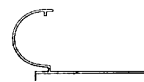

CP4



CP5

SECTION 23

POOL PAINT

ITEM NUMBER	CONTROL NUMBER	PRODUCT DESCRIPTION	PRICE
-------------	----------------	---------------------	-------

KELLEY EPOXY PRIMER

PRIMERS

PP-214G	43KP077914	Poxoprime II, gallon	\$134.00
PP-214QT	44KP024504	Poxoprime II, quart (WIL)	NLA
GUN-216G	45KP077914	Gunzite Primer, gallon	\$134.00
GUN-216QT	46KP025906	Gunzite Primer, quart (WIL)	\$40.00
MP-219G	47KP075009	Steel Primer, gallon	\$129.00
MP-219QT	48KP024509	Steel Primer, quart	NLA

KELLEY EPOXY POOL PAINT

POXOLON 2

#2228 Bikini Blue #2225 Blue Ice #2226 Black
 #2231 Blue Mist #2222 White

Batch Code	22KP116138	Poxolon Gallon with Catalyst	\$199.00
Batch Code	23KP033607	Poxolon Quart with Catalyst (WIL)	NLA
* Special colors available. Set-up charges apply			\$107.00
ES-1109QT	24KP013234	Epoxy Solvent #1109, quart	\$20.35
ES-1109G	25KP037009	Epoxy Solvent #1109, gallon	\$56.20

ZERON

#392 Bikini Blue #390 White #399 Black
 #395 Blue Mist #391 Blue Ice

Batch Code	26KP124005	Zeron Gallon with Catalyst	\$212.00
Batch Code	27KP037802	Zeron Quart with Catalyst	NLA
*Special colors available. Set-up charges apply			\$107.00
ES-1109QT	28KP012604	Epoxy Solvent #1109, quart	\$19.30
ES-1109G	29KP036759	Epoxy Solvent #1109, gallon	\$75.00

ACCENT & DESIGN EPOXY

POXOLON BRIGHT COLORS---Catalyst included in price

BCP-2201G	49KP141001	#1 Red Pepper, gallon	\$215.00
BCP-2201Q	53KP052001	#1 Red Pepper, quart	\$80.00
BCP-2203G	50KP141003	#3 Sunshine Yellow, gallon	\$216.00
BCP-2203Q	54KP052003	#3 Sunshine Yellow, quart	\$80.00
BCP-2211G	51KP141004	#11 Spanish Blue, gallon	\$216.00
BCP-2211Q	55KP052003	#11 Spanish Blue, quart	\$80.00
BCP-2212G	55KP141003	#12 Viking Blue, gallon	\$216.00
BCP-2212Q	56KP052009	#12 Viking Blue, quart	\$80.00

- POXOPRIME II**
- * Seals surface
 - * Reduces downtime
 - * Cleans up with water

- GUNZITE**
- * Filler & primer
 - * Apply over gunite
 - * Smooth finish

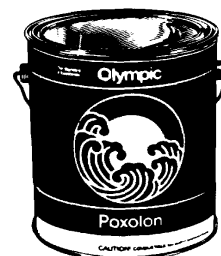

- POXOLON 2**
- * 2 coat epoxy
 - * Tile-like finish
 - * Resists staining
 - * Easy to clean surface

- ZERON**
- * One coat epoxy
 - * 2 times thicker than Poxolon
 - * Lasts up to 8 years

- BRIGHT COLORS**
- * Artistic decorative colors
 - * Accent & detail images
 - * Highlight for safety purposes

SECTION 23

POOL PAINT

ITEM NUMBER	CONTROL NUMBER	PRODUCT DESCRIPTION	PRICE
CHLORINATED RUBBER BASE			
PARALON 2			
	#292 Bikini Blue	#291 Blue Ice	#290 White
	#295 Blue Mist	#297 Black	
Batch Code	KP090005	Gallon	\$158.00
Batch Code	KP028703	Quart (WIL)	\$44.00
* Special colors available. Set-up charges apply			\$107.00
RBS-1108G	11KP038478	Solvent #1108, gallon	\$75.00
RBS-1108QT	12KP014008	Solvent #1108, quart	\$26.22



PARALON 2

- * Soft Pastel Finish
- * Easy to apply
- * Long Lasting

PATIO TONES

- * Makes It New Again
- * Covers ugly repairs
- * Non-slip Finish

PATIO TONES			
Desert Sun, #W-463		Warm Biscuit, #W-478	
Sand Valley, #W-465		Creekstone, #W-466	Ivory, #W-475
Champagne, #W-469		Silk Straw, #W-467	Mystic Gray, #W-472
Batch Code	KP057001	Gallon	\$98.00
Batch Code	KP017501	Quart	NLA
* Special colors available. Set-up charges apply			\$100.00

POX-O-FILL

- * Hi-strength epoxy
- * Fills large cracks
- * No "cold joint"
- * Anchor compound

CONCRETE PATCH

- * Economical
- * Easy application
- * "Holds" underwater

THERMOLASTIC

- * Expansion joints
- * Stays flexible
- * Can be painted

REPAIR PRODUCTS

CONCRETE REPAIR PRODUCTS

POF-962G	57KP089232	Pox-O-Fill #962, gallon w/ catalyst	\$138.00
POF-962QT	58KP035003	Pox-O-Fill #962, quart w/ catalyst	\$50.00
CP960G	59KP058005	Concrete Patch #960, gallon, w/ catalyst	\$81.00
CP960QT	60KP021008	Concrete Patch #960, quart, w/catalyst	\$30.00
TL-935V	60KP135004	Thermolastic #935, gal, vertical, w/cat	\$193.00
TL-935V	60KP047504	Thermolastic #935, Qt, vertical, w/cat	\$67.00
TL-935H	61KP135007	Thermolastic #935, gal, horizontal, w/cat	\$193.00
TL-935H	61KP047507	Thermolastic #935, QT, horizontal, w/cat	\$67.00

A paint job is only as good as the surface preparation. You want it so clean you could "eat off of it".

Step #1---Clean the pool surface with #910 Pool Wash to break down oils and dirt left on the surface...
rinse...pump out the rinse water.

Step #2---Acid wash surface with a 2:1, water to muriatic acid...rinse...pump out acid solution carefully.

Step #3---Repeat Step #1...allow surface to dry and reach proper temperature before applying paint.

OR DO IT THE EASY WAY!

Step #1---Mix **PREP MAGIC** according to directions (**PREP MAGIC** + water)...apply to surface.

Step #2---Allow surface to dry and reach proper temperature before applying paint.

See page 59 for "**PREP MAGIC**"



SECTION 23

PAINT ACCESSORIES

ITEM NUMBER	CONTROL NUMBER	PRODUCT DESCRIPTION	PRICE
-------------	----------------	---------------------	-------

PREP MAGIC--Concentrated Liquid Concrete Cleaner & Prep

245	63KP035887	Gallon PREP MAGIC	\$55.37
-----	------------	--------------------------	---------

POOL WASHING COMPOUND

TSP-910G	64KP025909	Pool Wash #910 (TSP), gallon (4000 sf)	\$39.60
TSP-910QT	65KP007708	Pool Wash #910 (TSP), quart (1000 sf)	\$11.77

SKID MIX---Non-skid Paint Additive

SM-905G	62KP018905	Skid Mix #905, gallon	\$14.98
SM-905QT	63KP007704	Skid Mix #905, quart	\$11.77

PAINT TOOLS

X87009	67KP009804	Roller Cover, 9", 1/2" nap Synthetic Fiber	\$14.98
9600/9004H	68AB029396	Acid/Tile Brush w/60" Thrd. Handle	\$49.00
9600	69AB019087	Dual-Sided Acid Brush Only	\$31.40
9004H	70AB010318	60" Thrd. Wooded Handle	\$17.00

PREP Magic--One Step Surface Preparation

- * Use w/ water for prep.
- * Low Odor.
- * Turns 3 steps into 1 step.
- * One gal / 400 S.F.
- * Biodegradable

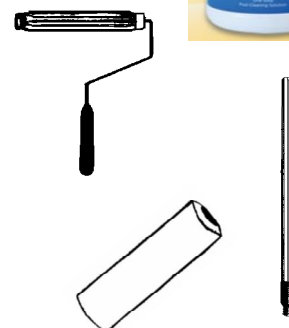
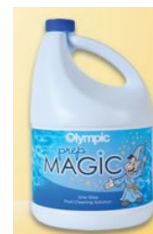

SECTION 24

EPOXY PRODUCTS

ITEM NUMBER	CONTROL NUMBER	PRODUCT DESCRIPTION	PRICE
-------------	----------------	---------------------	-------

EPOXY BOND POOL PUTTY: 2-part epoxy sticks
Available in "White" or "Black" color

530318-1	17PP017345	Pool Putty, 1# 2-part kit (White)	\$24.73
530318-5	18PP082304	Pool Putty, case 5 x 1# 2- part kit	\$117.50
530317-1	19PP025465	Pool Putty, 1# 2-part kit (Black)	\$36.33

530350	20PP036377	5# Tub Concrete Pool Patch Just add water, hardens in minutes	\$51.90
--------	------------	--	---------



Notes:

SECTION 24

CAULK & SEALANTS

ITEM NUMBER	CONTROL NUMBER	PRODUCT DESCRIPTION	PRICE
-------------	----------------	---------------------	-------

POLYURETHANE JOINT SEALANTS

VUL45SSL	16PP039808	Vulkem 45 SSL, 30 oz tube limestone Other colors: white, black, gray & buff	\$59.70
VUL116	25PP012507	Vulkem #116, 10 oz., white or alum Other colors: gray, black & buff	\$18.75

PERMANENT SEALER

PS-W	19PP007067	White, 10.3 oz. caulk tube	\$9.90
PS-W24	20PP155223	White, case 24 x 10.3 oz. tubes	\$217.00
PSW-HV	24PP007224	White, <i>HI-Viscosity</i> 10.3 oz. tube	\$10.15
PSW-HV-24	25PP158765	White, case 24 x 10.3 <i>H-V</i> tubes	\$222.30
PSCG-HV	26PP007226	Aluminum, 10.3 oz caulk tube	\$10.15
CPS-HV	29PP010151	Clear, 10.3 oz. caulk tube	\$14.25
80131-B	30AG007022	Clear 3oz. Silicone Adhesive caulk tube	\$9.90
PW-98	21PP005012	White Squeeze Tube, 4 oz	\$7.00
PC-98T	22PP005013	Clear Squeeze Tube, 4 oz	\$7.00

VULKEM 116:

* One-part polyurethane, non-sagging flex system
USE: Horizontal & vertical joint sealer

VULKEM 45 SSL:

* One-part polyurethane, *semi-self leveling* system
USE: Horizontal joints up to 6% slope.

PERMANENT SEALER:

* *Nitrile rubber* sealant for cracks & holes in concrete, wood, glass, & aluminum
* Flexible, fast-curing, self-leveling. Can apply underwater
USE: Horizontal seams

PERMANENT SEALER HV:

Same as above except:
* Non-sagging
USE: Horizontal & vertical seams

PVC GLUE..THREAD SEALANTS..LUBRICANTS

PVC PRIMER & CEMENT

795PT	01PA018406	Clear cement, #795, pint	\$29.75
P68PT	02PA014099	Primer, pint #P68	\$22.82
747QT	03PA018657	Blue cement, fast setting quart #747	\$30.25
747½PT	04PA008062	Blue cement, fast setting ½ pint #747	\$13.00



PIPE THREAD SEALANTS AND SILICONE LUBE

HTT260	05PA001709	Teflon Tape, 260" roll	\$3.25
HTT260-12	06PA018556	Teflon Tape, case of 12 x 260"	\$35.50
PJS1	07PA008519	Plasto-Joint Stick	\$12.80
PJS12	08PA047404	Plasto-Joint Stick, case of 6	\$71.25
R650	09PA007013	Magic Lube, 1 oz. silicone lube	\$9.90
R651	21PA025238	Magic Lube, 5 oz. silicone lube	\$35.33
R640	28PA010484	Magic Lube <i>Green</i> , 3 oz. w/ Kevlar	\$14.70



STAINLESS STEEL CLAMPS

277-32	24PF02521	Clamp, 1 9/16" / 2 1/2"	\$3.60
--------	-----------	-------------------------	--------

SECTION 26

PLUMBING SUPPLIES

ITEM NUMBER	CONTROL NUMBER	PRODUCT DESCRIPTION	PRICE
FLEXIBLE PVC			
120-0120	06P184700	3/4" x 100' Coil	\$298.00
FT	07PB02176	3/4" per foot	\$3.50
120-0130	08PB95398	1" x 50' Coil	\$154.00
FT	09PB02286	1" per foot	\$3.70
120-0180	10PB127705	1 1/4" x 50' Coil	\$207.00
FT	11PB002993	1 1/4" per foot	\$4.85
120-0140	12PB135993	1 1/2" x 50' Coil	\$190.00
FT	13PB003191	1 1/2" per foot	\$4.50
120-0150	15PB178464	2" x 50' Coil	\$250.00
FT	16PB004209	2" per foot	\$5.90
58308-100-000	17PB011310	PVC Hand Wire Saw Cable 36"	\$16.99

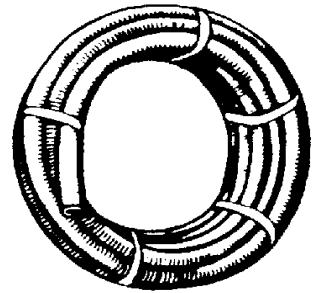

PVC PIPE FITTINGS- SCH 40

ELBOWS 1-1/2"

406-015	41PF02381	90° Elbow, 1 1/2" slip x slip	\$3.35
409-015	38PF04932	90° Street, 1 1/2" slip x slip	\$6.90
412-015	39PF05175	90° Street, 1 1/2" MPT x FPT	\$7.25
417-015	40PF03357	45° 1 1/2" slip x slip	\$4.70

ELBOWS 2"

406-020	42PF03736	90° Elbow, 2" slip x slip	\$5.25
409-020	84PF09653	90° Street Elbow, 2" slip x slip	\$13.50
417-020	85PF04378	45° Street, 2" slip x slip	\$6.20
21005-000-000	86PF05017	Sweep elbow- 2" x 2" slip x slip	\$7.00

SLIP ADAPTERS

436-015	28PF01839	Male Adapter, 1 1/2" slip x MPT	\$2.60
436-020	29PF02395	Male Adapter, 2" slip x MPT	\$3.40
435-015	30PF01836	Female Adapter, 1 1/2" slip x FPT	\$2.60
435-020	27PF02392	Female Adapter, 2" slip x FPT	\$3.40

COUPLINGS

429-015	53PF01461	1 1/2" slip x slip	\$2.06
429-020	48PF02249	2" slip x slip	\$3.20



SECTION 26

PLUMBING SUPPLIES

ITEM NUMBER	CONTROL NUMBER	PRODUCT DESCRIPTION	PRICE
-------------	----------------	---------------------	-------

PVC PIPE FITTINGS- SCH 40

TEES

401-015	44PF03163	Tee, 1½" slip x slip x slip	\$4.21
405-015	45PF08837	Tee, 1½" FPT x FPT x FPT	\$11.77
401-020	46PF04612	Tee, 2" slip x slip x slip	\$6.14

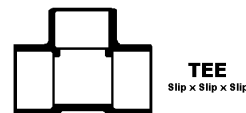

REPAIR FITTINGS-Mend & Repair PVC Fittings

21182-220	47PF10248	2" Socket Fitting Extension	\$13.55
21182-200	48PF08444	2" Fitting Extension	\$11.25
21182-150	49PF07995	1½" Fitting Extension	\$10.65



PIPE EXTENDERS-Mend & Extend PVC Pipe

21181-150	74PE05035	Extender for 1½" PVC pipe	\$6.70
21181-200	75PE05035	Extender for 2" PVC pipe	\$6.70

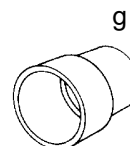

REDUCING BUSHINGS

437-251	49PF02799	Slip 2" x 1½" slip	\$3.72
436-251	51PF05803	Comb 2" x 1½" MPT x slip	\$7.73
439-251	35PF04938	2" x 1½" MPT x FPT	\$6.57
439-131	31PF02567	1" x ¾" MPT x FPT	\$3.41
439-168	32PF03812	1¼" x 1" MPT x FPT	\$5.08
439-210	33PF04619	1½" x ¾" MPT x FPT	\$6.14
439-211	34PF04615	1½" x 1" MPT x FPT	\$6.14
437-211	37PF001694	Slip 1½" x 1" slip	\$2.25
437-210	37PF001695	Slip 1½" x ¾" slip	\$2.25
438-210	36PF02966	Comb 1½" x ¾" slip x FPT	\$3.94
474-015	39PF04477	1½" Combo-poly insert x slip	\$5.96

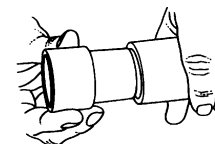

PVC UNIONS

PUMP TYPE HIGH TEMPERATURE UNION--MPT x slip

21063-154	01PV013731	1½" MPT w/ o-ring x 1½" slip	\$19.62
21063-200	02PV019192	2" MPT w/ o-ring x 2" slip	\$27.42

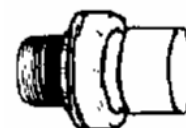

STANDARD UNION

21049-150	12AF11041	CMP union 1½" slip x slip	\$15.77
21049-200	13AF12573	CMP union 2" slip x slip	\$17.96



SECTION 26

PLUMBING SUPPLIES

ITEM NUMBER	CONTROL NUMBER	PRODUCT DESCRIPTION	PRICE
-------------	----------------	---------------------	-------

TRUE UNION BALL VALVES

Sch 80, EDPM seals

TRUE SINGLE UNION---Pinned for Easy Seat Removal for Servicing

*** A handle that turns...even with union nut over-tightened!

Our best seller...our best value !

ITUV1505E	69BV036826	1½" True double Union, s x s	\$51.60
ITUV2005E	70BV047567	2" True double Union, s x s	\$66.70

BALL VALVES ---Single Union

PV1450 -1½	14PV014854	1½" PVC Ball Valve, (S x S)	\$20.80
PT4-015	51PV024173	1½" PVC Ball Valve, (FPT x FPT)	\$33.99
PV1450-2	05PV019653	2" PVC Ball Valve, (S x S)	\$27.75
HMIP300SE	47PV049638	3" PVC Ball Valve, s x s (non-union)	\$69.50

Motorized or Manual Diverter Valves

263028	50PV057065	2" PVC Diverter Valve, 3-way , s x s x s Use manually or with an actuator for a motorized valve.**	\$79.90
263029	95PV048445	2" PVC Diverter Valve, 2-way , s x s Use manually or with an actuator for a motorized valve.**	\$67.90
263045	18G210106	**24 volt valve actuator for above valves	\$280.14

GATE & CHECK VALVES

GV200-150T	09PV036077	Bronze Gate Valve, 1½" MPT	\$50.50
GV200-200T	08PV055409	Bronze Gate Valve, 2" MPT	\$77.60
25830-150	09PV048153	Spring-load swing check valve, 1½"	\$67.50
25830-200	10PV049085	Spring-load swing check valve, 2"	\$68.75
R1520-15	09PV019622	PVC Swing Check Valve, 1½"	\$27.50
R1520-20	10PV029985	PVC Swing Check Valve, 2"	\$41.99

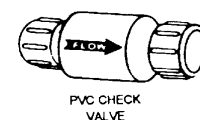
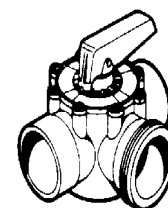
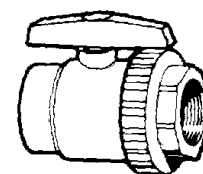
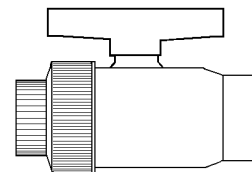

PVC CHECK VALVE

ITEM NUMBER	CONTROL NUMBER	PRODUCT DESCRIPTION	PRICE
-------------	----------------	---------------------	-------

BUTTERFLY VALVES

PVC Body, Flanged, EDPM Seals

PBFV3	25BF110549	3" Butterfly Valve	\$193.50
PBFV4	26BF124143	4" Butterfly Valve	\$218.00
PBFV6	27BF203717	6" Butterfly Valve	\$357.00
PBFV8	28BF300059	8" Butterfly Valve	\$525.99

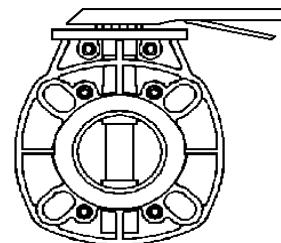

GEAR OPERATED BUTTERFLY VALVES AVAILABLE. CALL FOR PRICE.

FLANGES

Sch 80 Two-piece Van Stone Style

PF3	40BF012244	3" Flange	\$23.00
PF4	41BF016382	4" Flange	\$30.75
PF6	42BF026411	6" Flange	\$49.50
PF8	43BF042714	8" Flange	\$81.75

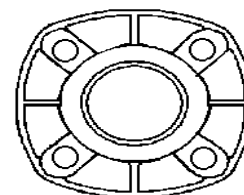

BUTTERFLY FLANGE BOLTS

BBK3	50BK09896	5/8" x 5 1/2", 4 per kit	\$16.48
BBK4	51BK18182	5/8" x 6", 4 per kit	\$30.30
BBK6	52BK23963	5/8" x 6 1/2", 8 per kit	\$39.93
BBK8	53BK26725	5/8" x 7", 8 per kit	\$44.53

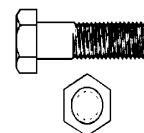

SECTION 27

DECK FORMS & DRAINS

ITEM NUMBER	CONTROL NUMBER	PRODUCT DESCRIPTION	PRICE
-------------	----------------	---------------------	-------

STEGMEIER CONCRETE COPING FORMS

CANTILEVER "REGULAR"---Case includes: 112' form, 112' tile strip, tie wire kit

DIG	01CF38000	Case 14/8', single case	\$505.00
1CF1122	02CF396150	Case 14/8', 2 or more cases, each	\$498.00

CANTILEVER "CAPSTONE"---Case includes 112' form, 112' tile strip, tie wire kit

9CF112	03CF38000	Case 14/8', single case	\$505.00
9CF1122	04CF396150	Case 14/8', 2 or more cases, each	\$498.00

CANTILEVER "SANDSTONE"---Case includes: 80' form, 80' tile strip, tie wire kit

17CF112	05CF38000	Case 10/8', single case	\$505.00
17CF1122	06CF396150	Case 10/8', 2 or more cases, each	\$498.00

STEGMEIER SUPER DECK DRAIN

SUPER DRAIN uses 1-1/2" sch. 40 PVC as adapters & couplings.

SRW (white)	01DW054848	Case 8 / 10' sections, includes: 8 couplers & 4 end adapters	\$685.00
SRG (grey)			
SRW-1 (W / G)	02DW72590	Super Drain, Single 10' section	\$90.74
SR9 (W / G)	07DW115298	Single 90° Angle (10 per carton)	\$20.39
SR4 (W / G)	08DW15299	Single 45° Angle (10 per carton)	\$20.39
SRT (W / G)	09DW25435	Single Tee (4 per carton)	\$33.91
SRX	10DW34588	Single Cross (2 per carton)	\$46.11
SRSA	11DW20805	Single Side Adapter (4 per carton)	\$27.73
SRDA	12DW20803	Single Down Adapter (4 per carton)	\$27.73

ROGERS stocks (W) white and (G) gray. (T)Tan & (B) black available by special order.

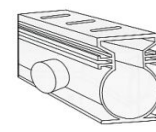
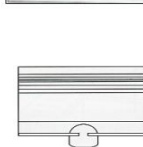
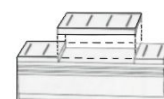
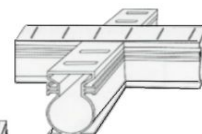
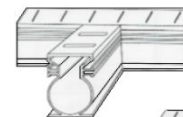
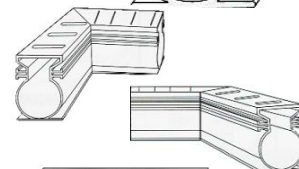
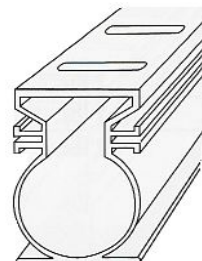
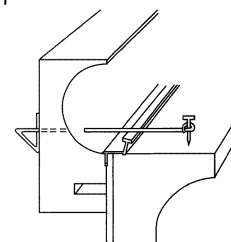
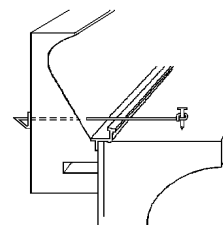
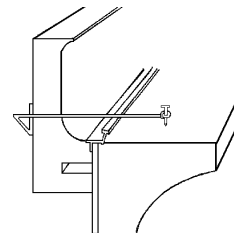

SECTION 28

DECK FOUNTAIN JETS

ITEM NUMBER	CONTROL NUMBER	PRODUCT DESCRIPTION	PRICE
-------------	----------------	---------------------	-------

CMP® DECK JETS™

Multi-Nozzle Adjustable Deck & Wall Jets Features:

- * Adjustable Flow at jet
- * Five interchangeable Nozzles
- * Four Color Options
- * Simple to Install and Operate



25598-300-000	01MN118290	Square Face with Flange (White)	\$165.00
25597-300-000	02MN118790	Round Face with Flange (White)	\$165.00
25598-343-000	03MN15082	Square Face with Flange (Brass)	\$211.00
25597-343-000	04MN15082	Round Face with Flange (Brass)	\$211.00

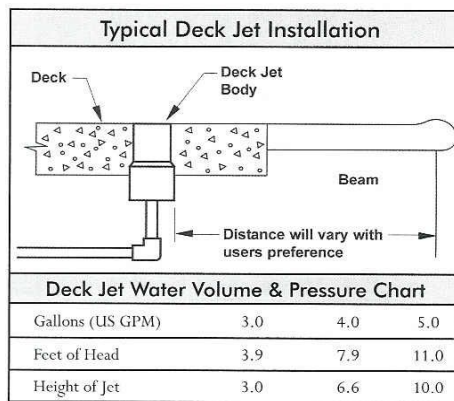

PENTAIR DECK JET

- * Includes five (5) interchangeable water effect eyeballs
- * Streams reach to 8 feet and direction can be easily adjusted
- * Jets install flush to surfaces
- * Easy to change water eyeballs
- * Low water pressure and flow required

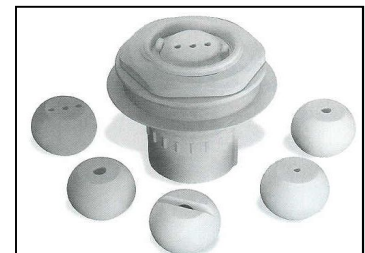

580000	45DJ158150	Pentair Deck Jet, each kit	\$228.00
--------	------------	----------------------------	----------

		THROW DISTANCE IN FEET						
		2	3	4	5	6	7	
Fan	gpm	-	1	1.2	1.3	1.5	1.9	
	psi	-	1.8	2.2	2.6	3.6	4.8	
	spread	-	12 in.	24 in.	36 in.	60 in.	96 in.	
3 Stream	height	-	12 in.	18 in.	24 in.	36 in.	48 in.	
	gpm	1.3	1.6	1.9	2.2	2.5	2.8	
	psi	2	2.5	3.5	4.2	5	6	
3/16 in. Single Stream	spread	8 in.	12 in.	18 in.	20 in.	24 in.	30 in.	
	height	9 in.	14 in.	20 in.	24 in.	30 in.	36 in.	
	gpm	0.4	0.5	0.7	0.7	0.8	0.9	
1/4 in. Single Stream	psi	1.5	2	2.4	2.8	3.2	3.8	
	height	10 in.	15 in.	21 in.	25 in.	31 in.	38 in.	
	gpm	1.2	1.5	1.8	2.0	2.2	2.5	
5/16 in. Single Stream	psi	2	2.5	3.2	4	4.6	5.5	
	height	10 in.	16 in.	22 in.	27 in.	32 in.	40 in.	
	gpm	1.5	1.9	2.3	2.6	2.9	3.2	
	psi	2	2.8	3.8	4.5	5.4	6.2	
	height	6 in.	9 in.	14 in.	17 in.	20 in.	26 in.	

Rogers Offers In-ground Pool Packages

STAINLESS STEEL WALLS

- * Stainless Steel + Concrete = Low Maintenance
- * Durable...Long-Lasting...Beautiful
- * Any Shape...Any Size...Any Custom Design
- * All Panels are pre-formed/pre-bent at factory
- * Perfect for Residential **and** Commercial Installation

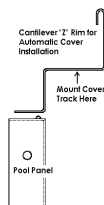

Special "Z" rim for automatic pool cover *under track* installation.

POLYMER WALLS

by Latham Pools

- * Non-corrosive...durable...long-lasting
- * Any Shape...Any Size...Any Custom Design
- * All Panels are pre-formed/pre-bent at factory
- * Large selection of liners available
- * Wide selection of steps available including:
Corner, radius, straight, Roman, wedding cake

GALVANIZED STEEL WALLS

by Latham Pools

- * Any Shape...Any Size...Any Custom Design
- * All Panels are pre-formed/pre-bent at factory
- * Large selection of liners available
- * Polymer and steel steps available

Rogers can price in-ground pool packages according to your requirements...complete or partial package or wall kit only.

800-752-5819

Call us for additional equipment and pricing.

STANDARD EQUIPMENT & SAFETY PACKAGE

Mechanical: (Sized to pool)
Pentair Sand Filter & Valve
Pentair WhisperFlo pump
Pentair SuperFlo pump



White Goods:
1-skimmer < 800 sq.ft. pool area
2-skimmers > 800 sq.ft. pool area
2-Return fittings w/eyeballs
1-Vacuum fitting
2- Main drains VGB

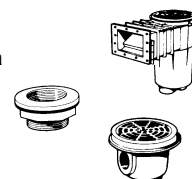

Lighting:
1-400w/120 V underwater light
1-Stainless Steel Light niche



Deck Equipment:
1-Stainless steel 3-Tread ladder
1-Channel deck anchor assembly
2-Stainless steel round escutcheons

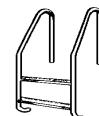

Diving pools:
1-S.R. Smith Flyte Deck dive stand
1-Frontier diving board



Maintenance: (Diving Pools)
1-Safety rope kit
2-Rope anchors & rope hooks
1-Deluxe vacuum head
1-Leaf skimmer
1-18" pool brush
1-Vacuum hose
1-skim-vac plate
1-8' - 16' Telescoping pole
1-Automatic chlorinator
1-Test kit, 4-in-one



Safety Plus Pkg:
(Indiana Residential Code)
Requires:
1-Coast Guard life ring
1-60' Throw line
1-12' pole with life hook



**** INDIANA Code requires Safety Items to be installed according to code.**

INDEX

A

Acid Wash Brush	33,57
Adaptor Light Ring	24
Air Blowers	42
Air Controls	48
Air Switches	48
Alarms-Child Safety	30
Algae Brush	35
Algaecides	4
Alkalinity Increaser	5
Anchors	
Pool cover	49,50
Ladders	17
Rope	26
Anti-Freeze	51
Aquamax Pool Cleaners	29,30
AquaCheck Test Strips	11
Aqua-Flo Spa Pump	38
Automated Sanitizer System	13-14
Automatic Vacuums	29,30
Automatic Water Fill	23

---B---

Backwash Hose	33
Ball Valves	61
Blowers, Spa	48
Blue & White Pumps	12
Board Mounting Kits	19
Brominators	12
Bromine Tablets	1, 7
Bronze Pumps	41
Brushes, Pool	33
Bulbs, Light	24
Butterfly Valves	62
By-pass Valves	61

---C---

Calcium Hardness Increaser	5
Calcium Hypochlorite	2
Cantilever Concrete Forms	63
Cartridge Filters	36-39
Caulking	58
Cement, PVC	58
Check Valves	61
Chemical Feed Pumps	12

C

Chlorinators	12-14
Chlorine	
Generator (Salt type unit)	13-14
Granular	1
Liquid	2
Neutralizer	1
Tablets	1
Stabilizer	1
Clamps, Stainless Steel	58
Clarifier, Pool	4
Cleaning Equipment	29-32
Collection Tube	22
Commercial Chemical Feeders	12
Commercial Pumps	41
Commercial Sand Filters	35
Concrete Forms	63
Concrete Repair	57
Coping	
Aluminum	53
Vinyl	53
Cover Cleaner & Deodorizer	6
Covers	
Spa	52
Winter	49,50

---D---

Deck Drain	63
Deck Jets	64
Defoamer	7
Depth Markers	28
Dial Valves	34
Diatomaceous Earth	34
Dive Board Refinish Kit	19
Dive Stands	20
Diving Accessories	19
Diving Boards	19
Draft Hoods	44
Duo Shock	2, 7

E

Electric Motors	42
Electric Pool Heaters	46
Emergency Equipment	26
Enzyme Treatment	3

E

Epoxy Pool Paint & Primers	55
Epoxy Putty	57
Escutcheons	17
Eyeballs	21

---F---

Fill Spouts	21
Filter Cleaner	6
Filters	
Cartridge	36
Sand	34,35
Filter Sand & Gravel	34
First Aid Kit	26
Fittings	
Hydrotherapy	23
Inlet	21
Plumbing	59-61
Vacuum	21
Flexible PVC Pipe	59
Float Keepers	26
Floats	26
Floats for Rope	26
Floating Chlorinators	12
Floc	4
Flow Meters	38
Foam, Pool Bottom	53
Frames & Grates	22

---G---

Gas Heaters	43,44
Gauges, Pressure	34
Glue, PVC	58
Grab Rails	17

---H---

Handicap Hydraulic Lift	16
Handles, Vacuum	31
Handrails	17
Head Immobilizer	26

INDEX

H

Heaters--- Pool & Spa	43-46
Heat Pumps	43
Hooks, Rope	26
Hose	
Backwash	33
Vacuum	32
Hydro Therapy Fittings	23
Hydro-static Relief Valve	22

---I---

Inlets	21
IntelliTouch	47

---J---

Jandy Gas Heaters	43
Jump Dive Stands	20

---K---

---L---

Ladders	17
Ladder Accessories	18
Leaf Eater	32
Leaf Rakes	33
Leaf Skimmers	33
Leaf Trap	31
Lens, Light	24
Len Gordon Switches	48
Letro—Legend Pool Cleaner	29
Lifeguard Chairs	20
Life Hooks	26
Life Rings	27
Life Ring Hangers	27
Lift Chairs	16
Light Accessories	24
Light Bulbs, LED Bulb Kit	24
Lights & Niches	25
Liners	54
Liner Bead Lock	53
Liner Receptor	53
Liquid Acid	2
Liquid Chlorine	2

---M---

Magic Lube	58
Main Drains (VGB)	22
Master Temp Gas Heaters	44
Mini Vac	31
Motors / SVRS	40,42
Multiport Valves	34,35
Muriatic Acid	2

---N---

Niches & Lights	25
-----------------	----

---O---

OTO, Reagents	8-10
Oxy-Clear	2
Ozone Generators by Del	15

P

Pentair Pumps	39
Paint & Paint Supplies	55-57
Painting Accessories	57
Paralon, Rubber Base Paint	56
Patching Compounds	56
Patio Tones, Deck Paint	56
Permanent Sealer	58
PH Decreaser/Incraser-Pools	5
PH Plus/Minus for Spas	7
Plasto-Joint Stick	58
Plugs, Winterizing	51
Plumbing Fittings	59-62
Poles, Vacuum	31
Pole Hangers	31
Pool Chair Lifts	16
Pool Cover Accessories	51
Pool Bottom Foam	53
Pool Kits	65
Pool Putty	57
Pool Washing Compound	57
Portable Cartridge Filter	36
Poxolon, Epoxy Paint	55
Poxoprime, Epoxy Primer	55
Prep Magic	57
Pressure Gauge	34
Pulsafeeder pumps	12

---P---

Pumps	
SVRS Pump / Motors	40
Filter	34-36
Motors	42
Pool Cover	38
Submersible	38
PVC Pipe Fittings	59-61

---R---

Reagents	10
Repair Products	55-57
Replacement Cartridges	37
Rope	26
Rope Anchors	26
Rope Hooks	26
Rubber Base Pool Paint	56

---S---

Safety Solid Cover	49
Safety Mesh Cover	49
Safety Equipment	26-28
Salt/Chlorine Generators	13-14
Sand & Gravel	34
Sand Dollar filters	34
Sand Filters	34-36
Scum Bug	6
Scum Mitt	6
Scrubbers	33
Sealants	58
Sequest	4
Shock Treatment	2
Signs	27
Silver Algacide	4
Skid Mix	57
Skimmer Accessories	21
Skimmers	21
Skim Vacs	32
Slides	18
Slide Repair Kits	18
Soda Ash	5
Solution Tanks	12
Spa Covers	52

INDEX

---S---

Spa Heater	46
Spa Wand	31
Spine Board	26
Stainless Steel Clamps	58
Stain Prevent & Remover	4
Staineraser	33
Stop Leak	5

---T---

Tagelus Filters	34
Taylor Test Kits	8
Teflon Tape	58
Telescoping Handles	31
Test Kits	8, 10-11
Test Strips	11
Thermometers	28
Thread Sealants	58
Tile & Vinyl Cleaner	6
Transformers	24
Triton Sand Filters	35
Tubing Slide Kits	18

---U---

Underwater Lights	25
Unions	60

---V---

Vacuum Fittings	32
Vacuum Gauge	34
Vacuum Heads	31
Vacuum Hose	32
Vacuuming Equipment	32
Valves	
Ball, Check, Gate	61
Multiport	34
Vent Caps	43,44
Vinyl Liners	54
Vinyl Repair Kits	53
Vinyl Repair Cement	53

---W---

Water Tubes	50
Waterfalls	24
Weirs	21
Whisper-Flo pumps	39
Winter Covers	
Supreme Guard	48
Safety Mesh Covers	49
Safety Solid Covers	49
Winterizing Plugs	51
Wipe Out	6

TABLE OF CONTENTS

	PAGE
CONDITIONS OF SALE	A
RETURNED GOODS & RESTOCKING POLICY	B
CHEMICALS	SECTION 2 1-7
WATER TESTING	SECTION 3 8-11
CHEMICAL FEEDERS	SECTION 4 12
ALTERNATIVE SANITIZING EQUIPMENT	SECTION 5 13-15
HANDICAP ACCESSORIES "ADA"	SECTION 6 16
DECK EQUIPMENT	SECTION 8 17-20
WHITE GOODS: INLETS, SKIMMERS, (DRAINS VGB)	SECTION 9 21-23
LIGHTING & BULBS	SECTION 10 24-25
SAFETY EQUIPMENT	SECTION 12 26-28
SIGNS and SAFETY EQUIPMENT	SECTION 12 29
POOL MAINTENANCE	SECTION 14 31-35
FILTERS: SAND, CARTRIDGE	SECTION 16 34-37
FLOWMETERS	SECTION 16 38
ANTI-ENTRAPMENT PUMP & MOTORS	SECTION 17 40
PUMPS & MOTORS & SVRS UNIT	SECTION 17 39-42
HEATERS: POOL & SPA	SECTION 18 43-46
POOL CONTROL SYSTEMS	SECTION 19 47
AIR BLOWERS	SECTION 19 48
SAFETY MESH & SOLID WINTER COVERS	SECTION 21 49
WINTER COVERS & ACCESSORIES	SECTION 21 50-51
SPA COVERS	SECTION 21 52
VINYL LINERS & ACCESSORIES	SECTION 22 54
PAINT: POOLS & DECKS	SECTION 23 55-57
PAINT ACCESSORIES & CONCRETE REPAIR	SECTION 23 57-59
CAULKING & REPAIR PRODUCTS	SECTION 24 58
PLUMBING: FITTINGS, VALVES, UNIONS, ETC.	SECTION 26 59-62
CONCRETE COPING FORMS	SECTION 27 63
DECK DRAINS	SECTION 27 63
DECK FOUNTAIN JETS	SECTION 28 64
IN-GROUND POOL KITS	SECTION 29 65
INDEX	66-68

ROGERS & CO.

RETURNED GOODS & RESTOCKING POLICY

merchandise will not be accepted for return without prior written authorization from ROGERS & CO. Returned shipments not having prior approval will be refused. All returned merchandise must be new, unused and in saleable condition except defective goods. Up to a 20% restocking charge will be applied against any credit issued for saleable merchandise. All goods must be returned freight prepaid within 30 days after receipt of shipment. Return authorization number must appear on all cartons. Products sold by ROGERS & CO. are covered by manufacturers' warranties, either expressed or implied. See TERMS page for additional terms and conditions.

RESTOCKING CHARGES:

1. Return of special order products is subject to a 20% restocking charges.
2. Stocking products returned under 30 days of purchase is subject to a 5% restocking charge.
3. Stocking products returned after 30 days of purchase is subject to a 10% restocking charge.
4. Products being returned out of box and/or not in original packaging are subject to a 20% restocking charge.
5. Warranty/defective products pending authorized factory representative inspection are not subject to a restocking charge.
6. All freight cost incurred during warranty/restocking of a product will be billed back to the customer.
7. All returns made by ROGERS & CO. truck must have prior approval and a RGA (Returned Goods Authorization) number attached to all packages.

3/1/2017

B

ROGERS & CO. of INDIANA, INC.

This supersedes all prices and conditions of prior date.

- 1 **ACCEPTANCE OF ORDERS:** All orders are subject to acceptance by ROGERS & CO. of Indiana, Inc. in accordance
- 2 **PRICES:** Prices are for items. F.O.B. Indianapolis, IN., except as otherwise noted. Prices, discounts, quotations, and
- 3 **ROUTING:** If routing of shipment is specified on Buyer's orders, it will be followed whenever practical; however final c
- 4 **SHIPMENT:** Shipping dates are based upon complete and accurate identification of the items being ordered. Shipme
- 5 **COMPLETENESS OF SHIPMENT:** All shipments made by Rogers are carefully checked prior to shipment. The Buy
- 6 **TRANSPORTATION CLAIMS:** Responsibility for safe shipment passes to the carrier upon shipment and the receipt
- 7 **TAXES:** Rogers' prices do NOT include sales, use, excise or similar taxes. The amount of any of the above taxes, pr
- 8 **TERMS:** Unless a written credit application has been signed and submitted, and approved by an authorized officer of
 - a. Payment in full is due within 30 days of date of invoice and is past due on the 31st day.
 - b. All prices are net. A 2% cash discount may be granted to accounts purchasing for resale only, provided the invo
 - c. Interest and service charge will be made on all balances not paid within 30 days of date of invoice plus any and
 - d. All payments must be made from the individual sales invoice. A statement is mailed to each account monthly w
- 9 **MINIMUM BILLING:** The minimum billing charge for items purchased on open charge is \$25.00 plus freight charge, f
- 10 **WARRANTY:** All items sold by Rogers are guaranteed by the manufacturers thereof and any claim is limited to the p
11. **RETURN OF GOODS:** Written permission from Rogers must be obtained before returning any items. Upon receipt of written au
12. **RIGHT TO SELL:** Rogers is a full service wholesale distributor. Mere possession of a Rogers price list of discount schedule by
- 13 **CATALOG & SPECIFICATION ILLUSTRATIONS:** The illustrations in catalogs and specification sheets supplied by I
- 14 **CONDITIONS:** All sales by Rogers are subject to these conditions. No exceptions will be accepted or honored unless

with the conditions herein Oral and phone orders are accepted provided the Buyer accurately and completely identifies the items being ordered. All specifications are subject to change without notice and will be applied as in effect at time of shipment.

Choice of routing shall be Rogers' choice based upon conditions which prevail.

Shipment will be made only after payment terms acceptable to Rogers have been made by the Buyer. No shipments will be made to delinquent accounts. The Buyer is totally responsible for checking the shipment against the Packing Slip immediately upon receipt. Any claim for shortage must be made by Rogers of a signed Bill of Lading. Any claims for shortages or damages, whether concealed or obvious, must be noted on the freight bill at the time of receipt or future, applicable to the sale or use of any items purchased shall be paid by the Buyer; or in lieu thereof, the Buyer shall provide a check for the amount of Rogers & Co. of Indiana Inc. prior to the requested delivery date, terms are cash-in-full with the order, or C.O.D (Collect on Delivery) A deposit

is paid in full within 10 days of its date, and also provided the account has no past due balance on other invoices. When granted, cash on delivery covers all collection and legal expenses incurred by Rogers to collect the past due balance.

Cash on delivery covers purchases from the 29th of one month through the 28th of the next month. This statement is merely to assist the Buyer in recording purchases, tax, etc.

Provisions of said manufacturer's guarantees. Said guarantees do not cover labor, consequential damages of any type, or anything relating to installation. Without authorization, the Buyer must ship to Rogers (or wherever instructed) prepaid; and no claim shall be recognized for such shipping costs. No person or company does not obligate Rogers to sell those parties/

Orders are intended to show the general features of the products or materials; but Rogers reserves the right to supply products and materials as agreed to in writing by an authorized officer of Rogers & Co. of Indiana, Inc. In all cases of conflict between these conditions and those of

ordered

accounts.

before the Buyer or his agent leaves Rogers' warehouse (in the case of pick-up); or before the carrier's driver leaves the delivery point. All upon receipt of the shipment by the Buyer, and must be filed with the Delivering Carrier by the Buyer or consignee. Any shortages or discrepancies with his order and before shipment a tax exemption certificate to Rogers which is acceptable to the taxing authorities. A deposit may be required for C.O.D. orders. The same terms may also apply on the sale of certain items to cash accounts with approved credit.

discount does not apply to freight, tax, or deposits of any type.

Reconciling his records with ours. A minus (-) appearing on the statement indicates a credit. If there are any questions anytime, please phone call.

to installation. Rogers will assist the Buyer in making a justified claim under the terms of the manufacturer's guarantee provided the time credit will be given for items not of current design, and items must be brand-new salable condition. If the items are in proper condition, credit will be given.

Materials of latest design and construction and of standard manufacture.

When the customer's purchase order or elsewhere, these conditions shall take precedence. The placing of an order with Rogers shall be an acknowledgment of these conditions.

Discrepancies between the contents of the shipment and the Packing List must be reported in writing to Rogers within 5 days of receipt of shipment.

The following terms apply to accounts with approved credit privileges:

Our accounting department.

Period for the guarantee has not expired and provided the Buyer has first actually inspected the equipment, identified the defect and its cause, credit may be given for the original purchase price less 20% handling/restocking charge.

Acceptance by the customer of all of the terms and conditions above.

ment. Full details, including the Packing Slip number, must be given.

use, and reported all such details to Rogers; and also provided the equipment was purchased from Rogers and the invoice number and d

ate are included in the Buyer's report. Written notice of any claim under warranty shall be delivered to Rogers by the Buyer within 30 days

of the occurrence of alleged defect. Rogers reserves the right to inspect any alleged defective merchandise at its location, or require the E

Buyer to return said merchandise to the factory at the Buyer's expense, for inspection under

